

DIY WOODEN BOOK NOOK

ASSEMBLY MANUAL

Abbey library

Maria Laach library Ages 14+





In medieval Western, European societies, there was neither printing technology nor printing equipment, and manuscripts were the only type of books available. The only people who hand-copied books were monks who could read and write Latin, so almost all libraries at this time were located in abbeys, the original 'libraries'.



CONTENTS

Safety Warning/Attentions	01
Maintenance	02
Assessories	02
Wooden Boards list	03
Paper Part Instructions	05
Assembly Instructions	06

Scan for High Definition Manual





安全警告

- 为了保障您在娱乐时的安全，请在拼装之前阅读说明书。
- 此产品适合 14 周岁以上的人群，儿童必须在父母指导下组装。
- 在未经授权的情况下擅自改变和修改本产品，将损害您有关本产品的权益。



Safety Warning

- To keep your safety, please read this manual prior to your start.
- This product is suitable for people aged above 14, children must assemble under the guidance of their parents.
- Any unauthorized alteration or modification of this product will impair your rights and interests related to this product.



注意事项

- 小心地从板上取下配件，防止零件断裂。断点可以用磨砂棒磨平
- 不要一次性将木板零件全部拆下来。产品需配合无毒环保胶水组装，胶水黏贴后需静置2小时达到最强固化，黏贴后请勿随意挪动。建议先进行黏贴部件后再组装其他接插件以节省等待时间。
- 本产品接插口的松紧程度是由加工工艺、环境温湿度决定。插接部位如果安装过紧，则需用磨砂棒将接口部位打磨再组装，如果安装过松，则需在组装后加胶水进行固定。
- 儿童在组装时需要成人陪同。
- 说明书上含有重要信息，请予以保留。



Attentions

- Carefully remove parts from the board to prevent parts from breaking. The breakpoint can be smoothed with a frosting rod.
- Do not detach all the parts simultaneously. Glue needs to be used at some points, After the glue is pasted, leave the product untouched for two hours to ensure a firm paste. To save time, you can do the pasting step first and then assemble the rest of plugins.
- The tightness of the connector is determined by the processing technology as well as the temperature and humidity of the environment. If the splicing part is too tight to be installed, you can polish it with a frosting rod before assembling it. If the installation is too loose, you can add some glue to fix it after assembly.
- Children need to be accompanied by adults when assembling.
- Please keep this instruction manual for future reference.



维护和保养

- 请勿将此产品靠近热源或浸入水中。并使用干净柔软的布清洁此产品。
- 请勿使用擦窗剂、喷雾剂、溶剂、酒精、氨水、研磨剂等化学清洁剂来清洁产品。



Maintenance

- Do not place the product near heat or in water. Clean the product with a clean soft cloth.
- Do not use the chemical cleaners to clean the product, such as window cleaners, sprays, solvents, alcohol, ammonia and abrasive.

质保与售后

- 感谢购买我们的产品，产品在发货前都会进行检查以确保配件齐全。
- 本套产品享有 12 个月的产品质量售后保障。如果您发现任何部件的疵或遗漏，可通过电子邮箱联系我们 :MinicityDeslgn@gmail.com，我们将会 在 12 小时内给予回复!

MINICITY 售后组

Warranty

- Thank you for purchasing the Book Nook Kit, and the package has been carefully checked before delivery to ensure that the accessories are complete and not missing.
- Should you experience any defects or missing parts, we will provide with extended 12months warranty. If you have any questions with the item, feel free to contact us by email: MinicityDesign@gmail.com, we will get back to you within 12H and MAKE IT RIGHT!

MINICITY Customer Support Team

组装前进行电池盒测试

如图,将LED灯的端口连接到电池盒的端口,插入两节7号电池,打开开关,测试灯是否亮







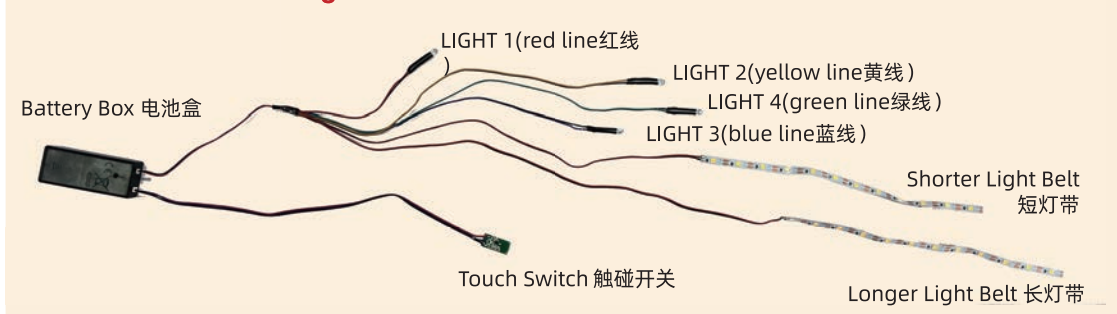



Test the LED before assembling

Connect the part of the LED light to the part of the battery box as shown, and insert two AAA batteries. Turn on the switch and test whether the lights are on.

Test Before Assembly Pls

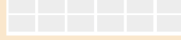

配件 Accessories

 电池盒*1 Battery Box*1	 触碰开关*1 Touch Switch*1	 LED灯 *1 LED Light Set*1	 LED灯带*2 LED Light belt*2	 铁丝*1 Iron Wire*1	 手工锤*1 Hammer*1
 防尘罩 Dust Cover*1	 贴纸*1 Stickers*1	 胶水*1 Glue*1	 纸配件(Adhesive) Paper1-4*1	 镊子*1 Tweezers*1	 磨砂棒*1 Frosted Rod*1



Wooden Boards list

Marking Reference Table

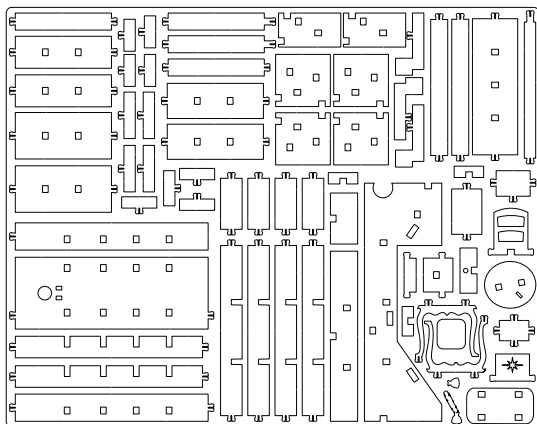

(A)

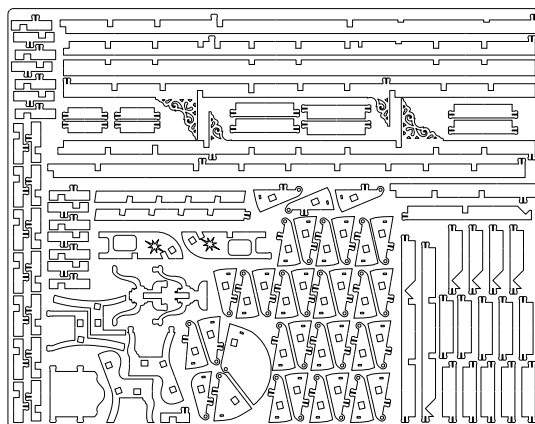

(B)

Tool for picking out 拆板工具

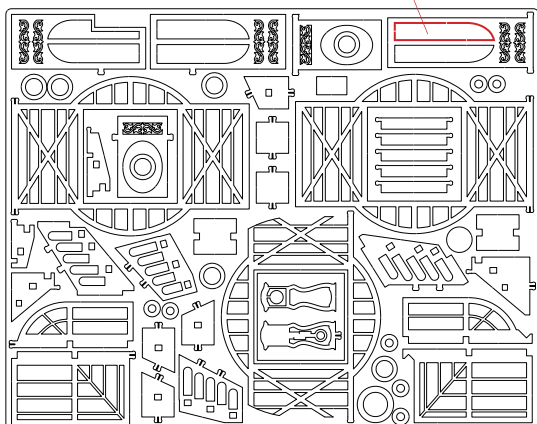

(C)

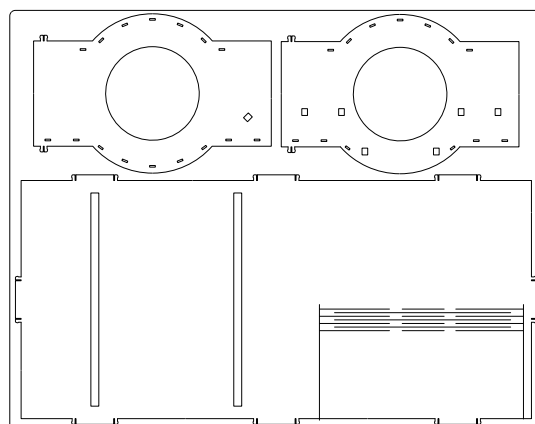

(D)

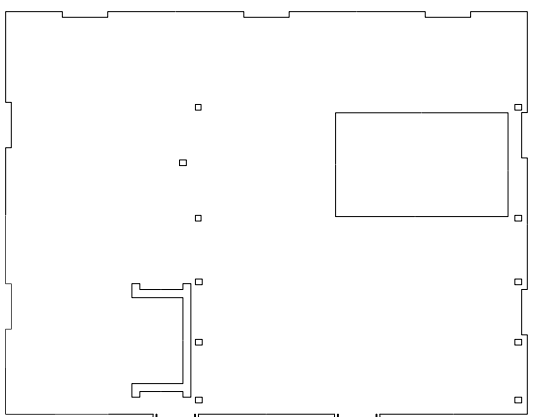

(E)

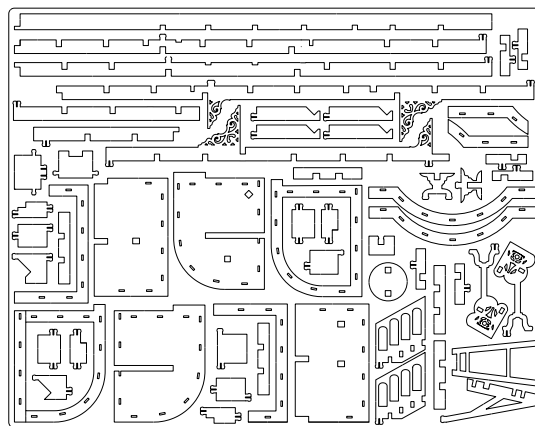

(F)



TIPS

J and K boards have protective coverings that are front facing to judge for the front side. Most of the installation steps shown in the illustrations are for the front side. Please remove the protective coverings before installation.

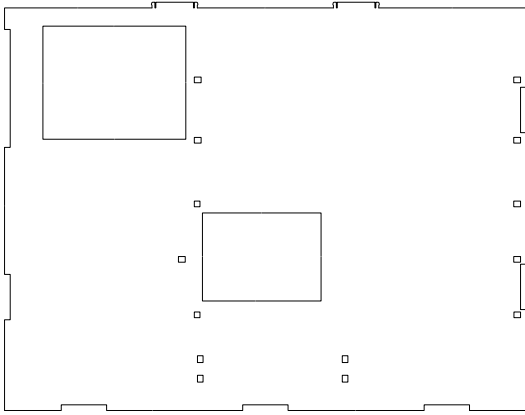

G

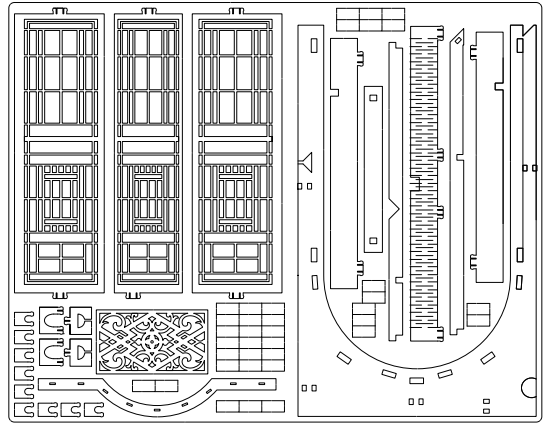

H

Paintings can be placed freely.
画可以自由摆放。

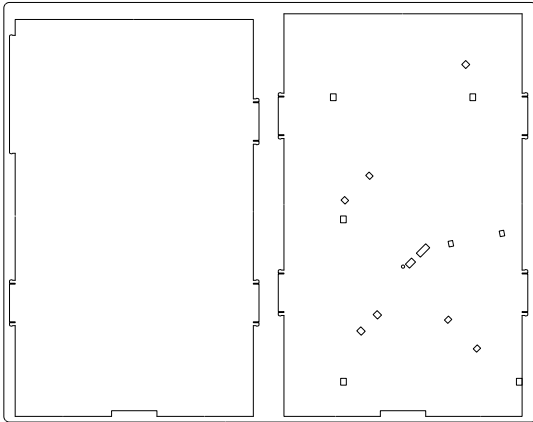

I

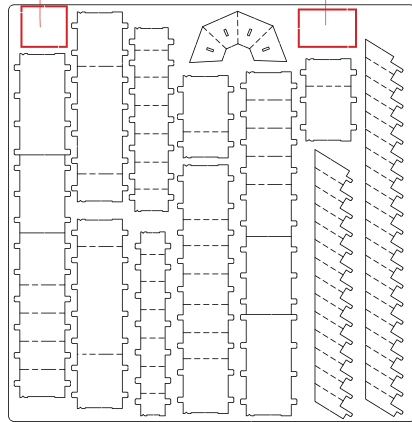

J

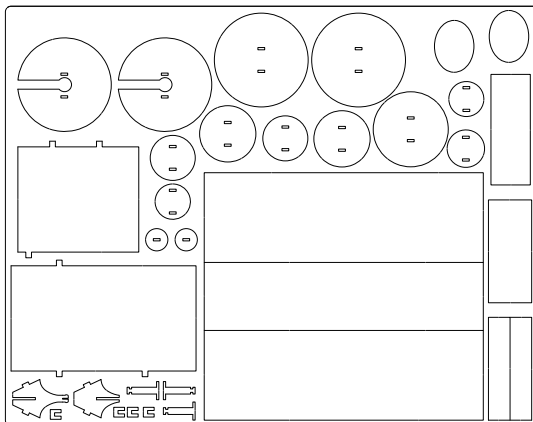

K

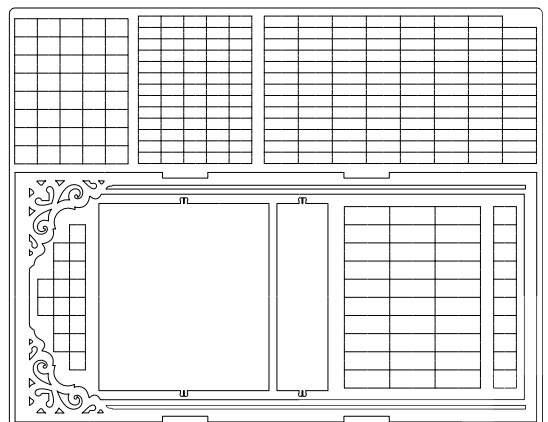

L



Paper Part Instructions



Paper1
Book Cover-A



L1 =



Book A



Paper1
Book Cover-B



L5 =



Book B



Paper1&Paper2
Book Cover-C



L4 =



Book C



Paper2&Paper3
Book Cover-D



E1&G1
&H8 =



Book D



Paper3&Paper4
Book Cover-E



L6 &
G2 =



Book E



+



Paper4
Folding Books-A

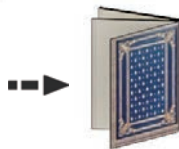

Folding BookA



Paper4
Folding Books-B

Folding BookB

Stick it on bookshelves or furniture. 贴在书架和家具上



Paper4
Rolling paper

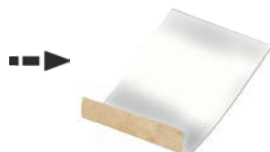

=>



Scrolls



Assembly Instructions

整个书立内部将会分为下图4个部分，我们将按照顺序逐一拼装完成。最后组装在一起，完成整个书立。为了保证拼装的效果，需要保证面对正面的都是有印刷颜色的面，让我们开始吧！

The interior of booknook will be divided into the following four parts, which will be assembled one by one in order. Finally put them together to complete the entire booknook. In order to increase efficiency, it is necessary to ensure that the front faces are colored. Let's do it together!



PART 01

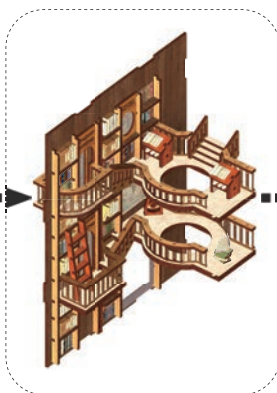

PART 02



PART 03



PART 04

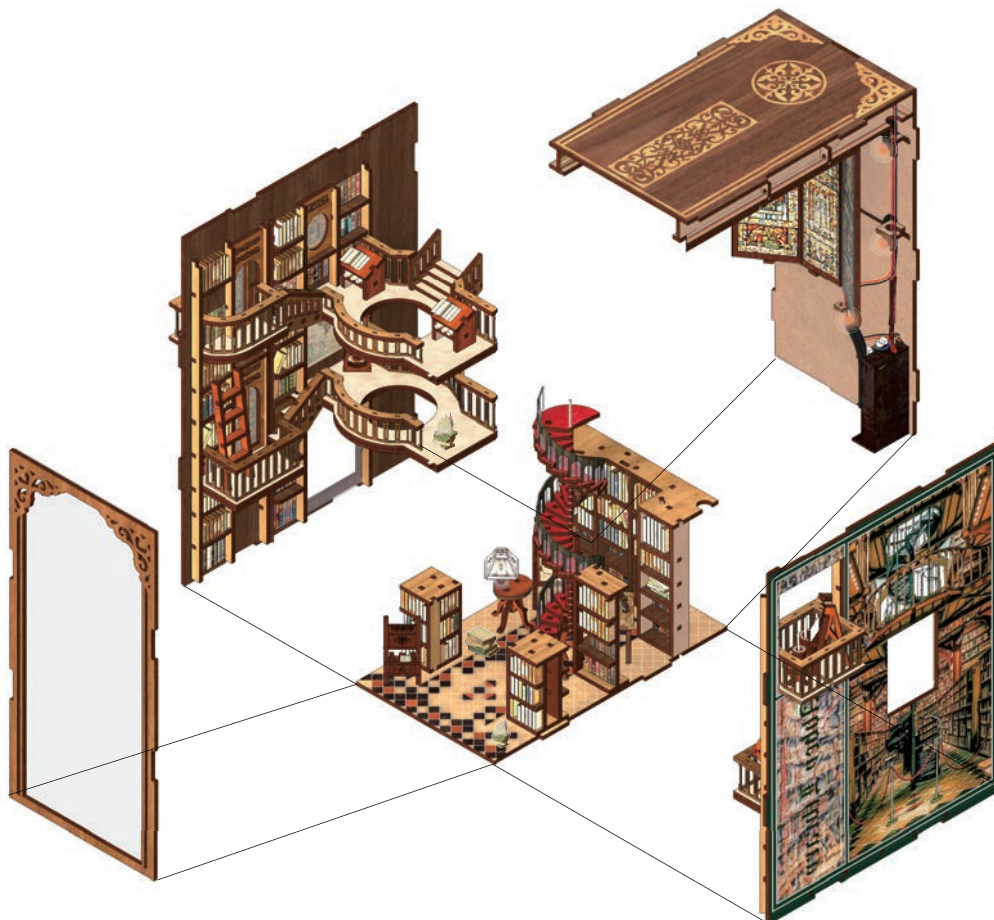

PART 1

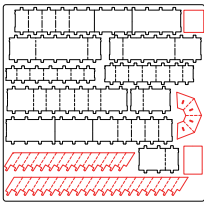

J

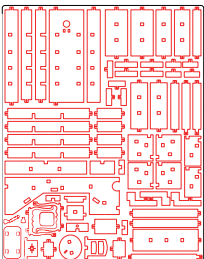

A

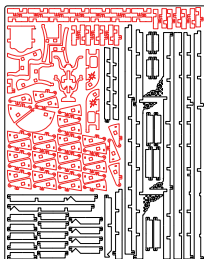

B

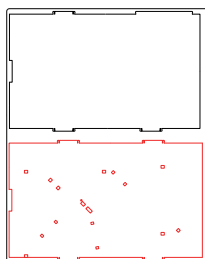

I

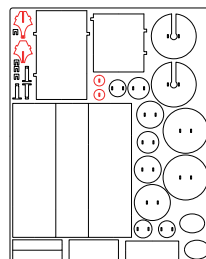

K

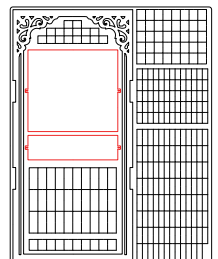

L

STEP 01

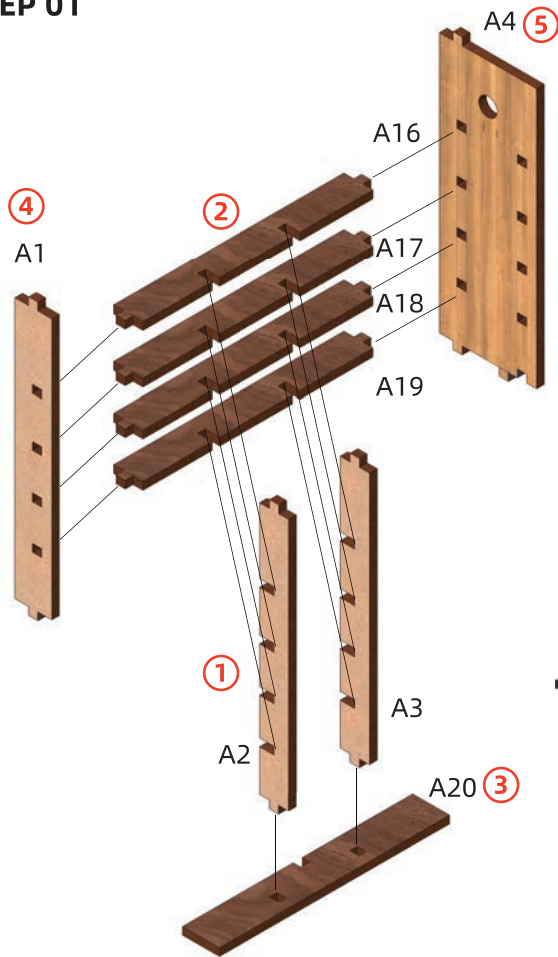

TIPS

Pay attention to the position of boards-A1,A2,A3 to prevent upside down installation.
注意A1,A2,A3板的位置，预防上下颠倒安装。

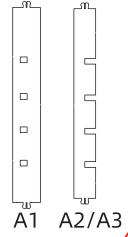

STEP 02

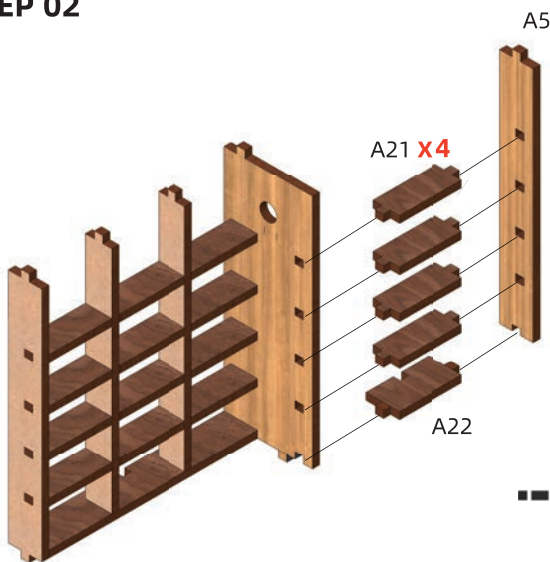

STEP 03

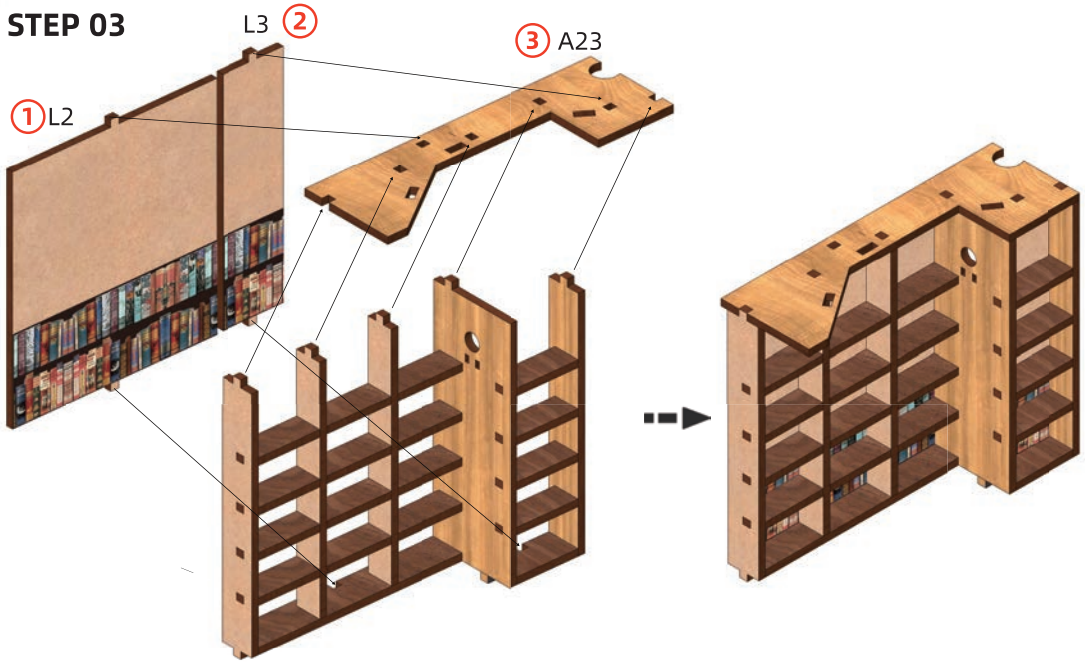

STEP 04

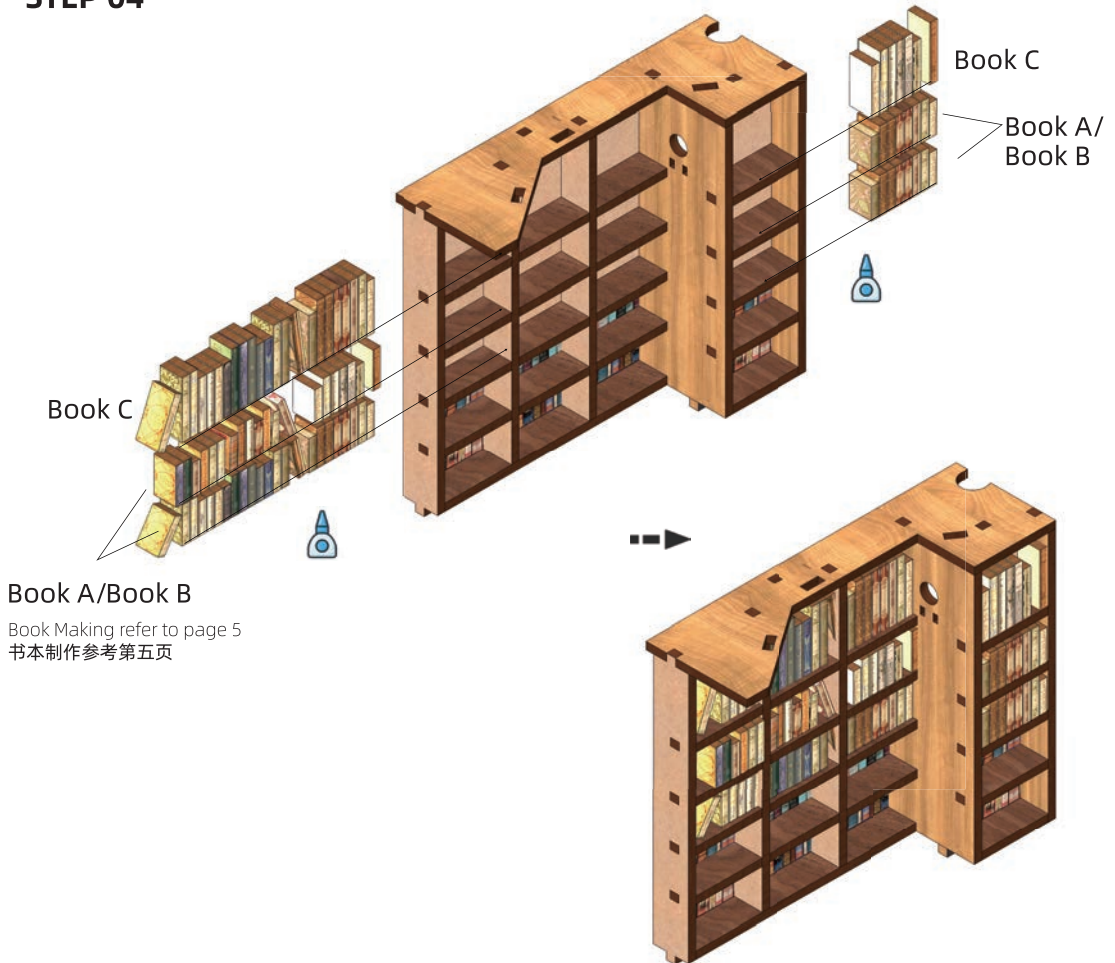

STEP 05

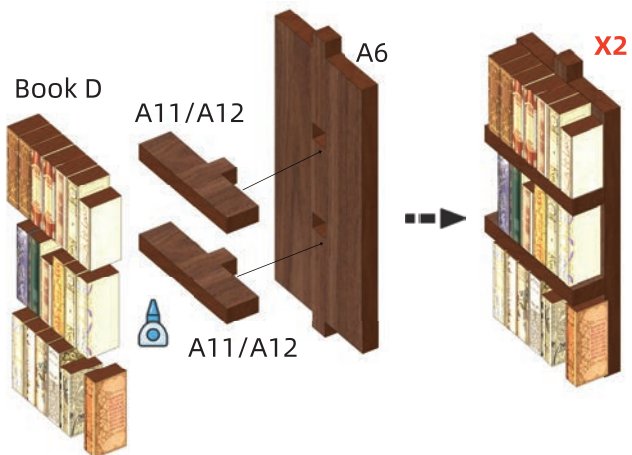

STEP 06

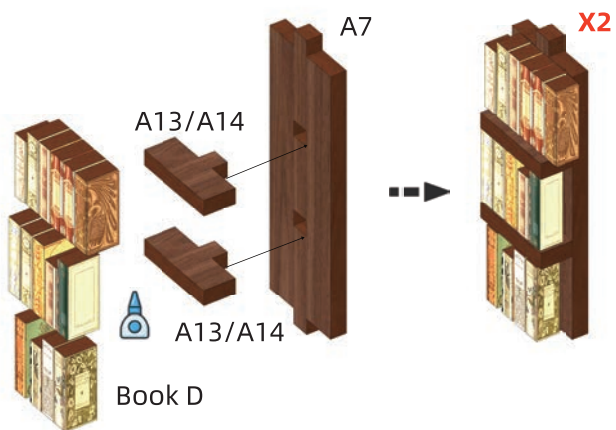

STEP 07

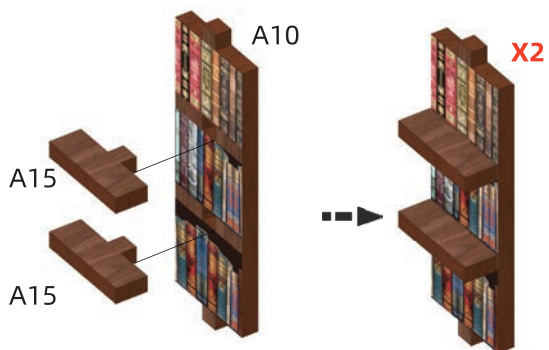

STEP 08

TIPS
Pay attention to the position of A9 to prevent upside down installation.
注意A9板的位置，预防上下颠倒安装。

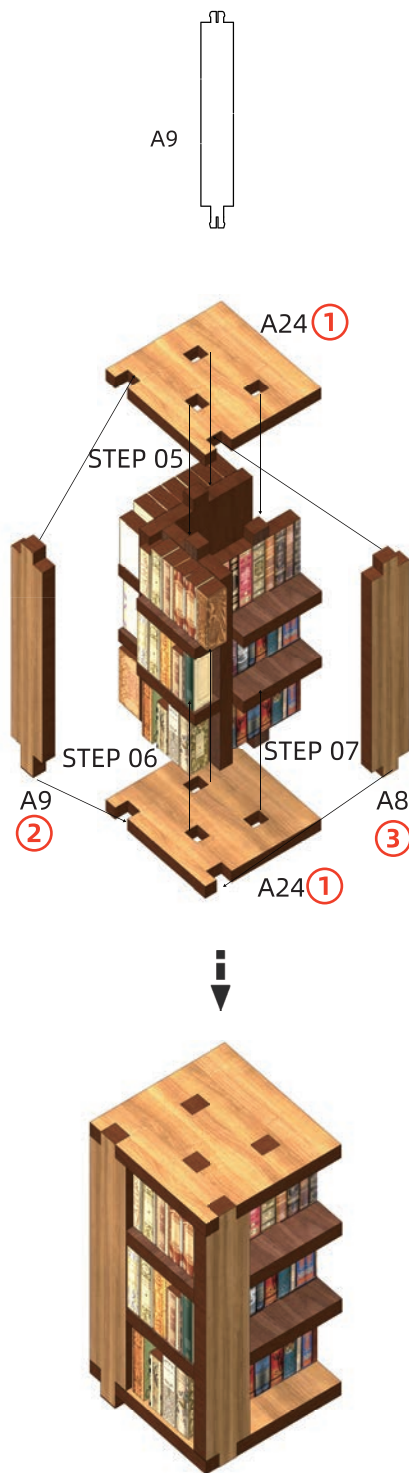

STEP 09

TIPS

Pay attention to the position of A9 to prevent upside down installation.
注意A9板的位置，预防上下颠倒安装。

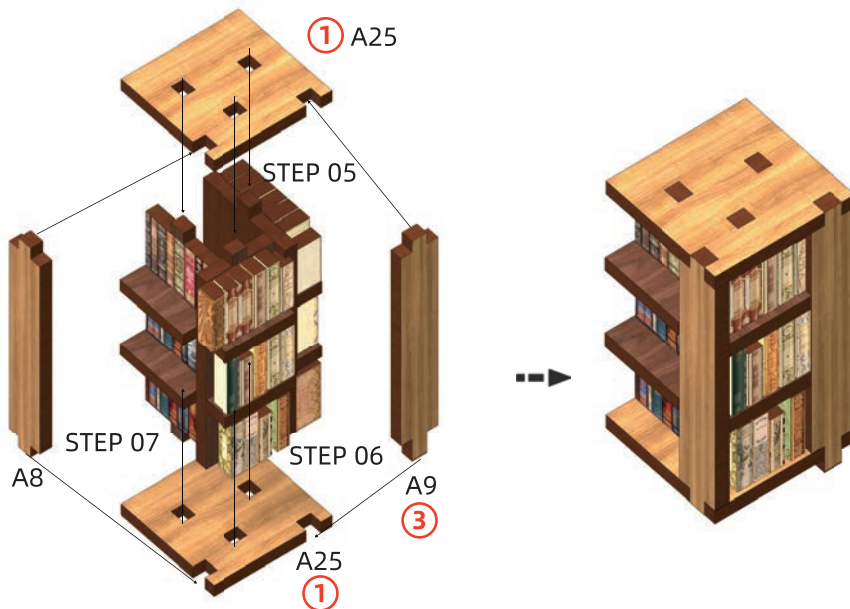

STEP 10

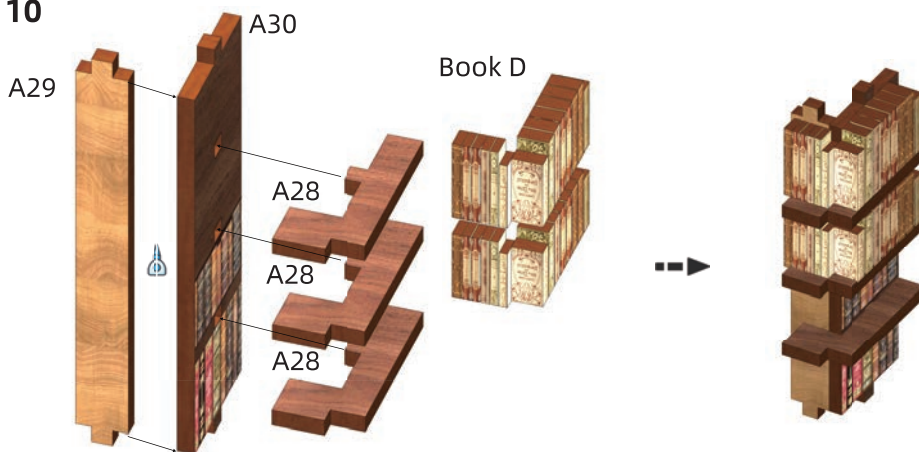

STEP 11

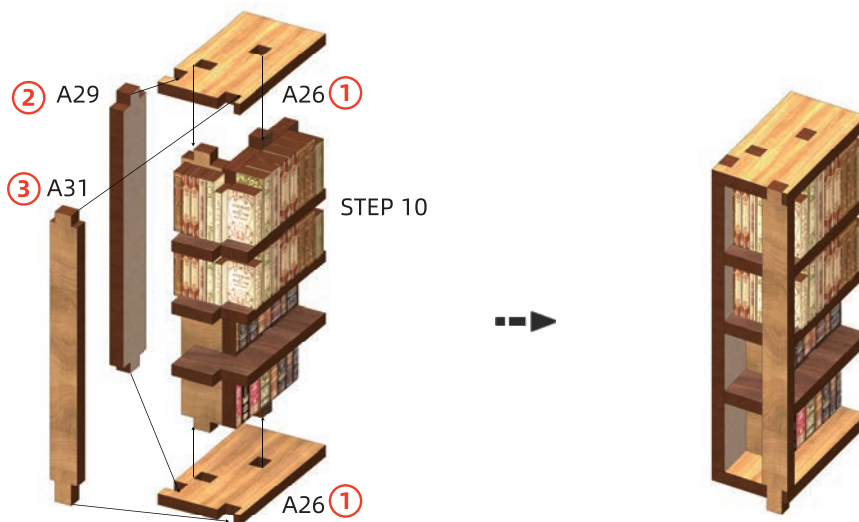

STEP 12

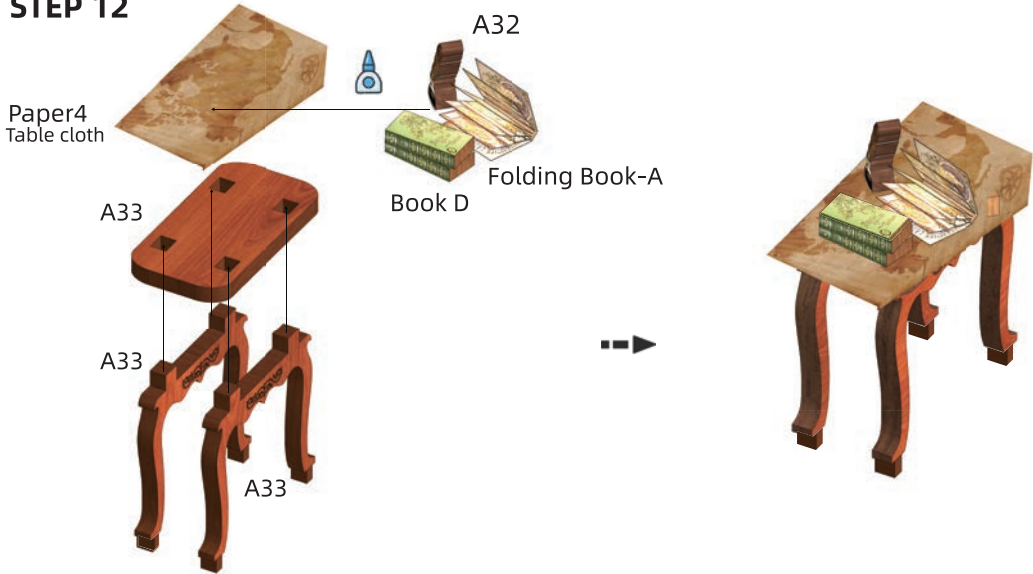

STEP 13

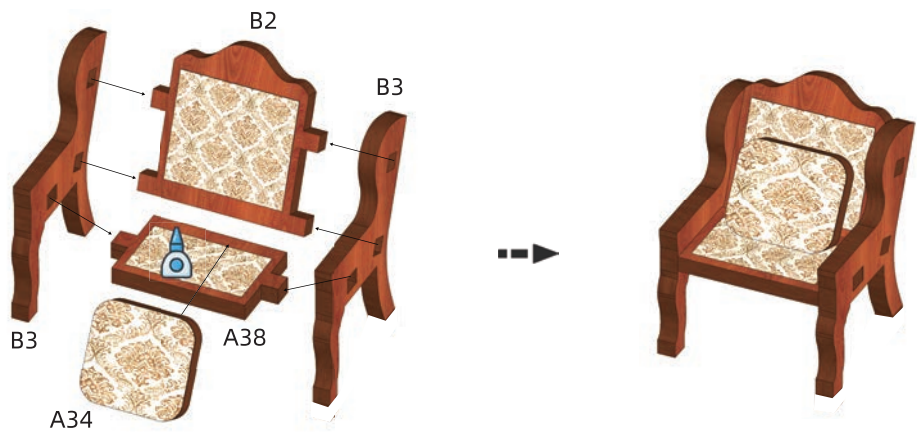

STEP 14

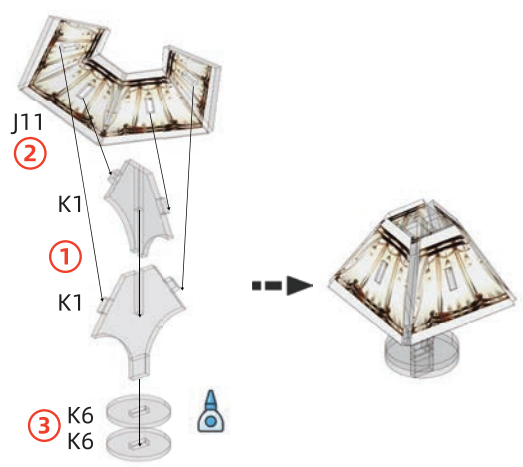

STEP 15

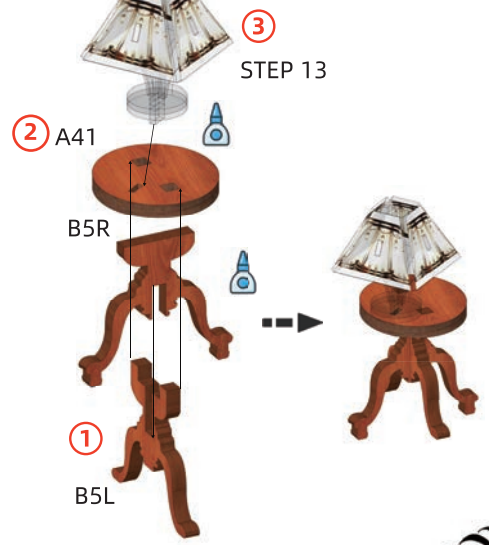

STEP 16

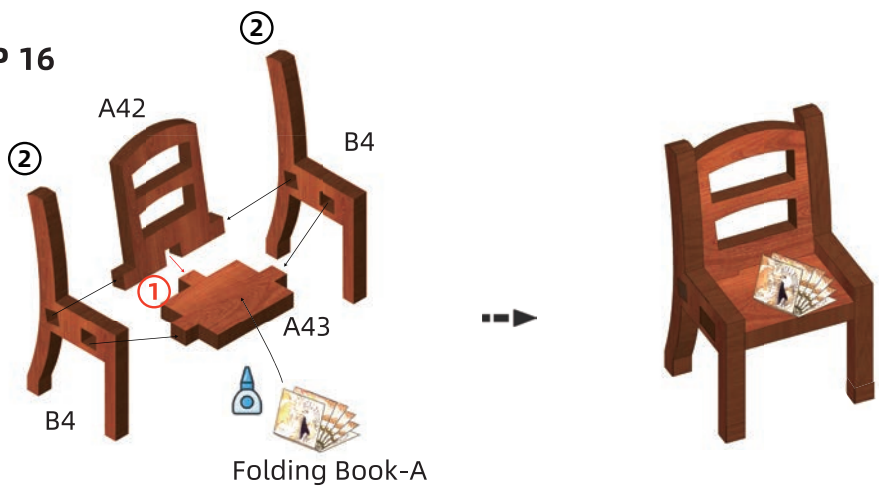

STEP 17

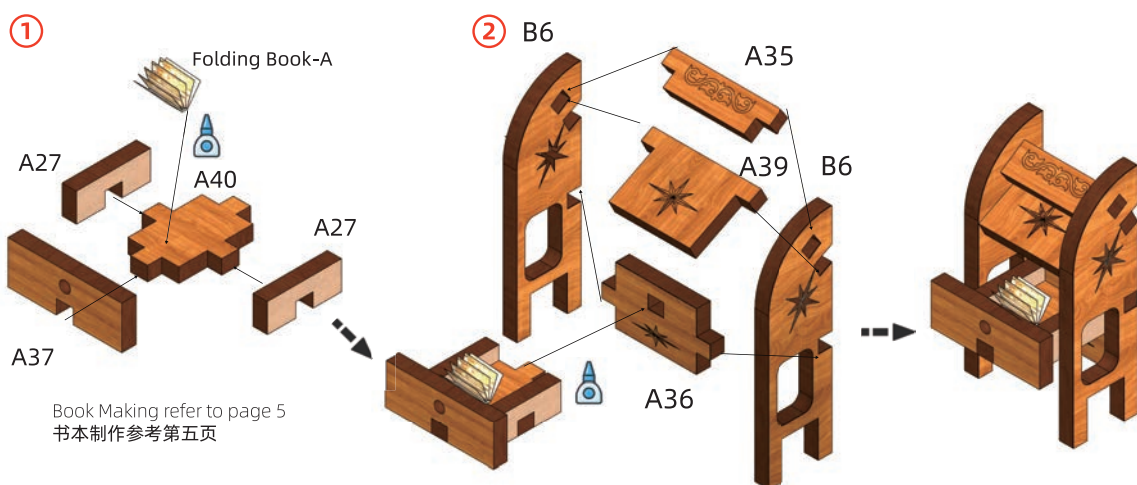

STEP 18

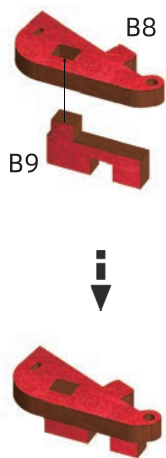

STEP 19



STEP 20

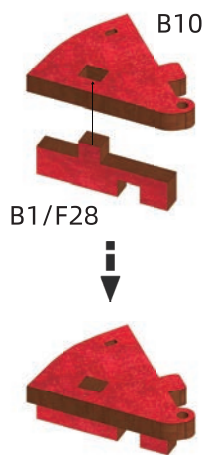

STEP 21

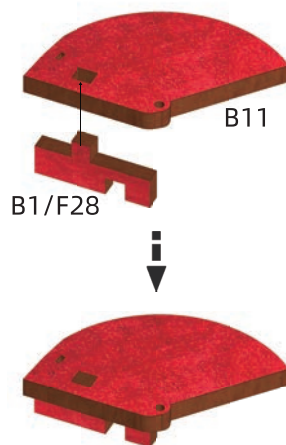

STEP 22

- ① Prepare 19 pieces of step19, step18 and handrail J12, and install these stairs to the handrail from top to bottom in the following five steps.

准备19个台阶step19和1个台阶step18和扶手J12，按照下面五个步骤从上往下安装台阶到扶手上。

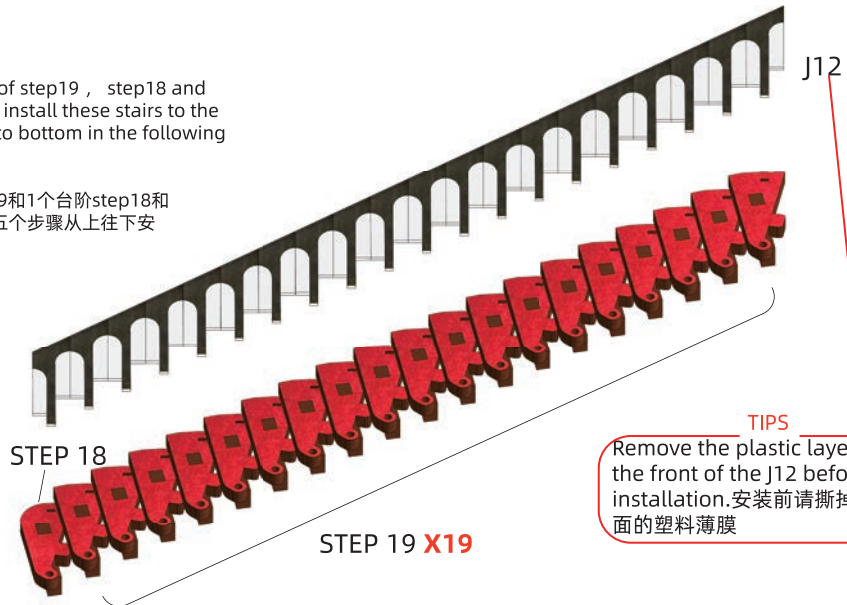

TIPS
Remove the plastic layer on the front of the J12 before installation. 安装前请撕掉J12正面的塑料薄膜

- ② Install step18 to J20 连接step18和J12

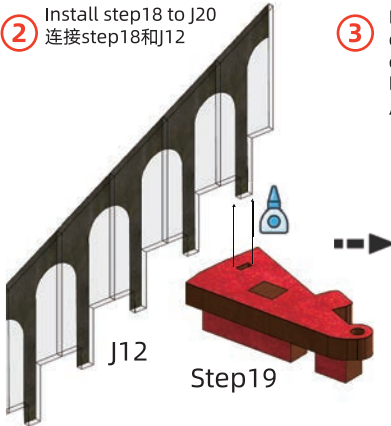

- ③ Folding handrail in small degrees around the axis of the disconnected line. 以断线为轴线小幅度折叠扶手

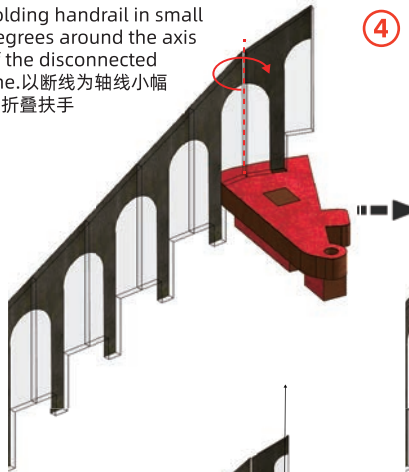

- ④ Installing Step18 on J12 and the installed step18. 新的step18连接J12和已经安装的step18

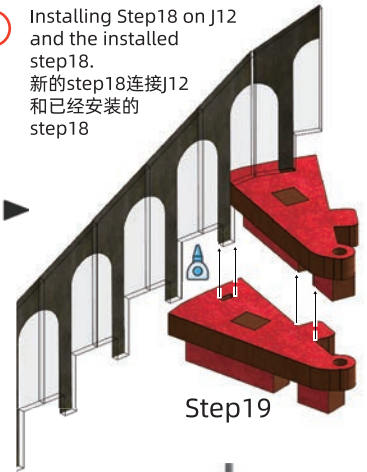

- ⑤ Repeat the above steps 2 and 3 until the second-to-last railing. 重复2和3步骤直到倒数

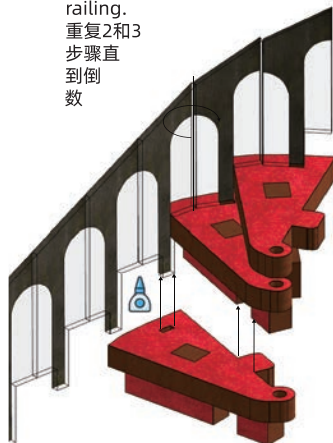

- ⑥ Install step17 to the last railing, and string wire to all steps. 最后一个栏杆安装step18和串铁丝

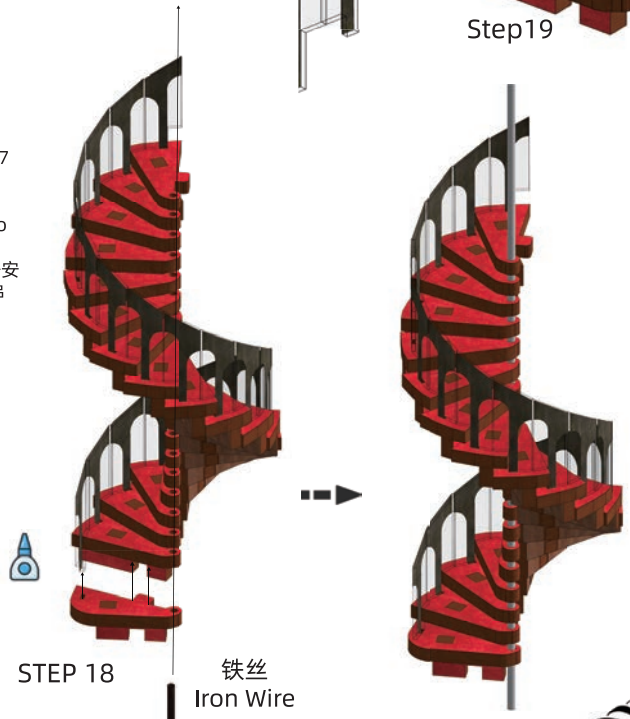

STEP 23

TIPS

1. According to step22 in the regularity of ③④; installing stairs on the handrail from the top to the bottom. The step21 stair installs on the first handrail, the step19 stairs install on the middle handrail, the step20 stair installs on the last handrail, the instructions are as follows.

按照step22里3,4的规律从上往下安装台阶到扶手上,第一个扶手安装step21,中间台阶安装step19,最后一个扶手安装step20,说明如下:

2. Remove the plastic layer on the front of the J9 before installation.

安装前请撕掉J9正面的塑料薄膜

- ① Prepare 12 pieces of step18, step19, step20 and handrail J9.
准备12个台阶step18, 1个台阶step19, 一个台阶step20和扶手J9。

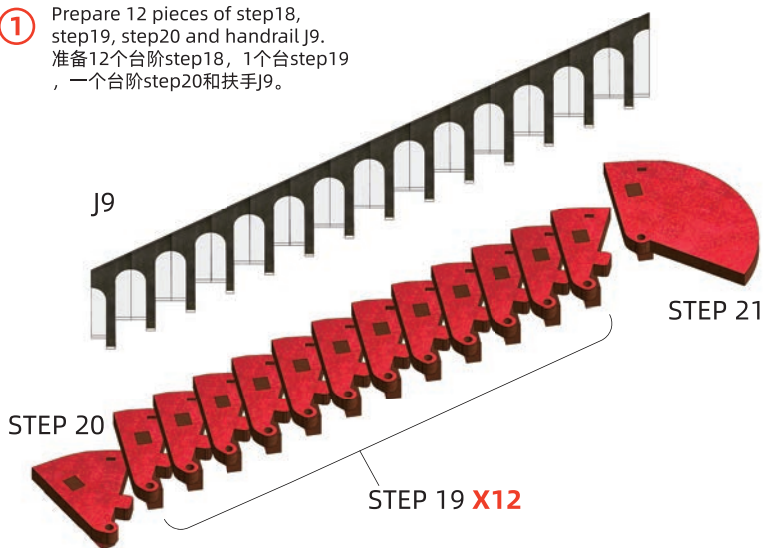

- ② Install step21 to J9
连接step21和J9

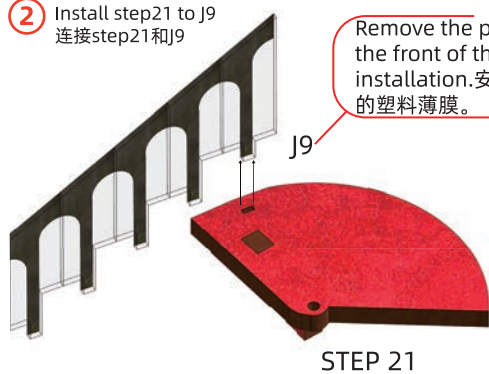

TIPS

Remove the plastic layer on the front of the J9 before installation. 安装前请撕掉J9正面的塑料薄膜。

- ③ Repeat ③④ in step22 until the second-to-last railing.
重复step22里的3和4步骤直到倒数第二个栏杆

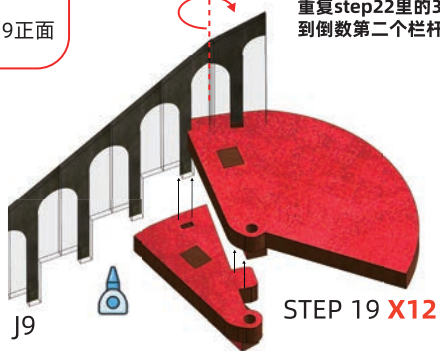

- ④ Install step20 on the last railing
最后一个栏杆安装step20

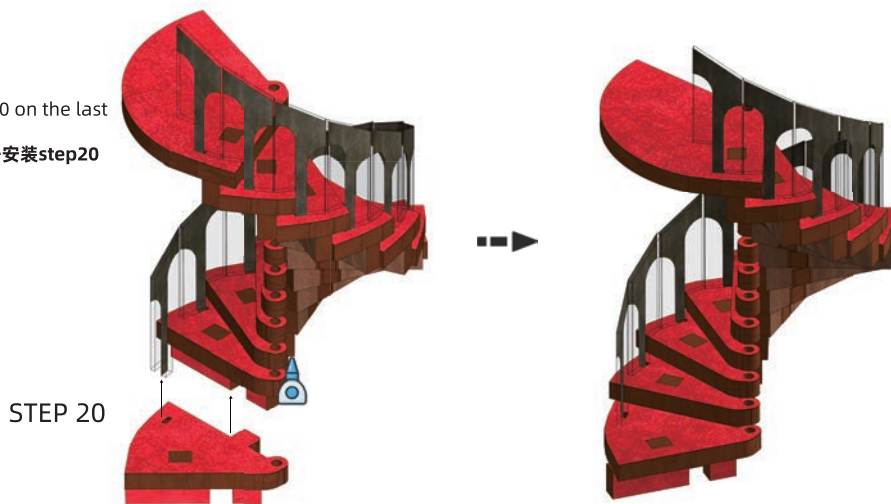

STEP 24

① All the stairs on step23 are skewed with iron wire.
串铁丝

② Rotate step22 and step23 to connect step22 and step23 on the axis of the iron wire.
旋转，连接step22和step23。

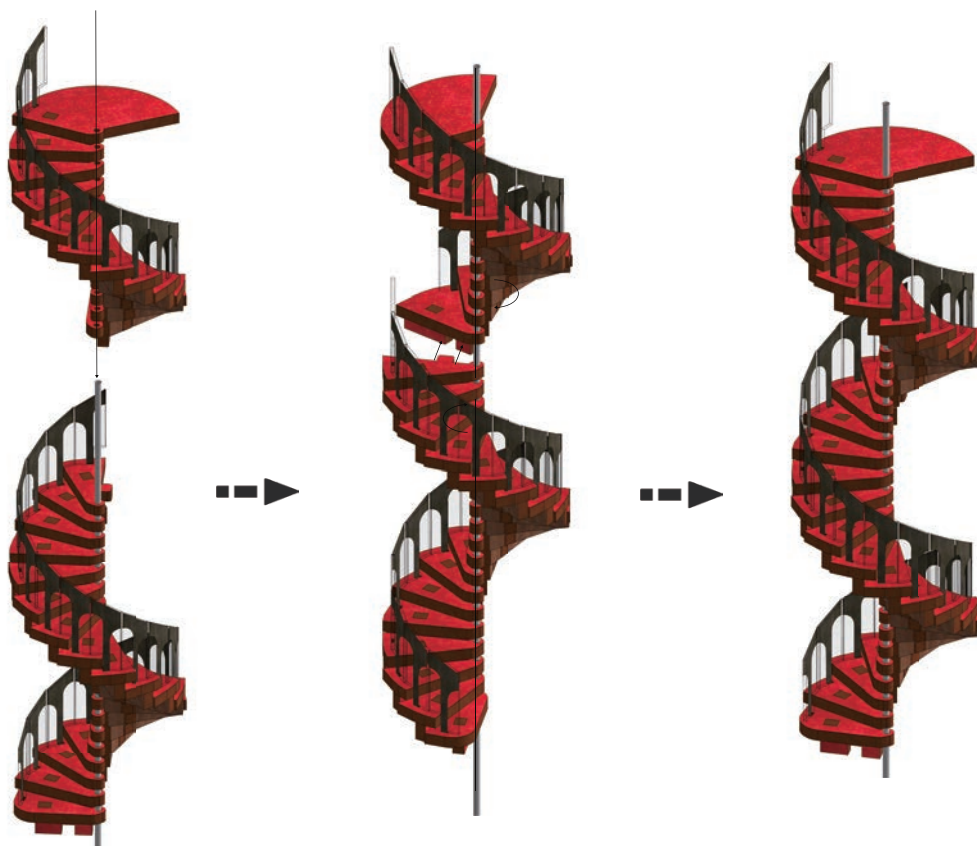

STEP 25

TIPS

The order of installation is from top to bottom, from left to right to install the furniture to the bottom board I board, please follow the red round box numerical order to install the furniture, the floor plan and the order of installation is as follows.

安装顺序从上到下，从左到右安装家具到底板I板上，请按照红色圆框数字顺序安装家具，平面图和安装顺序如下。

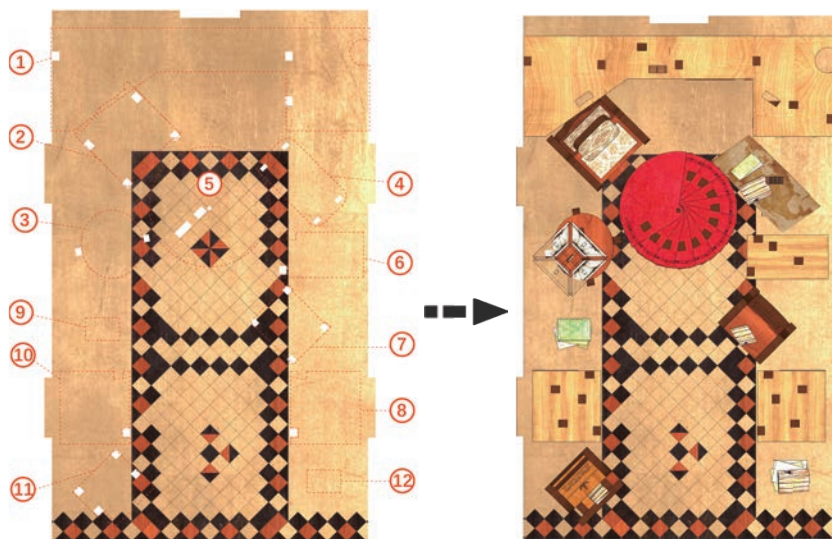

I2

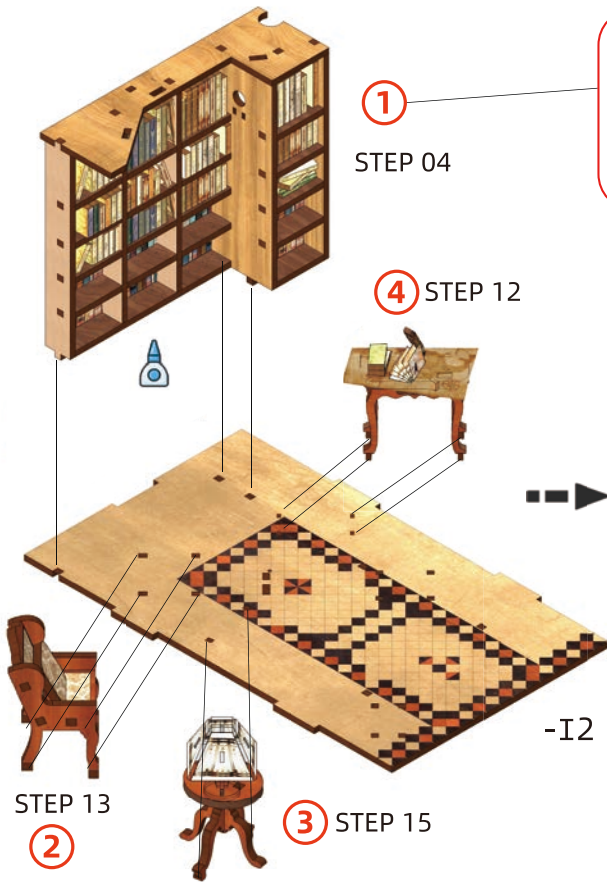

TIPS

Recommended to reinforce the fixing of Step03 on the bottom board-I2 contact surfaces with glue.

Step03和底板-I2的接触面建议用胶水加强固定

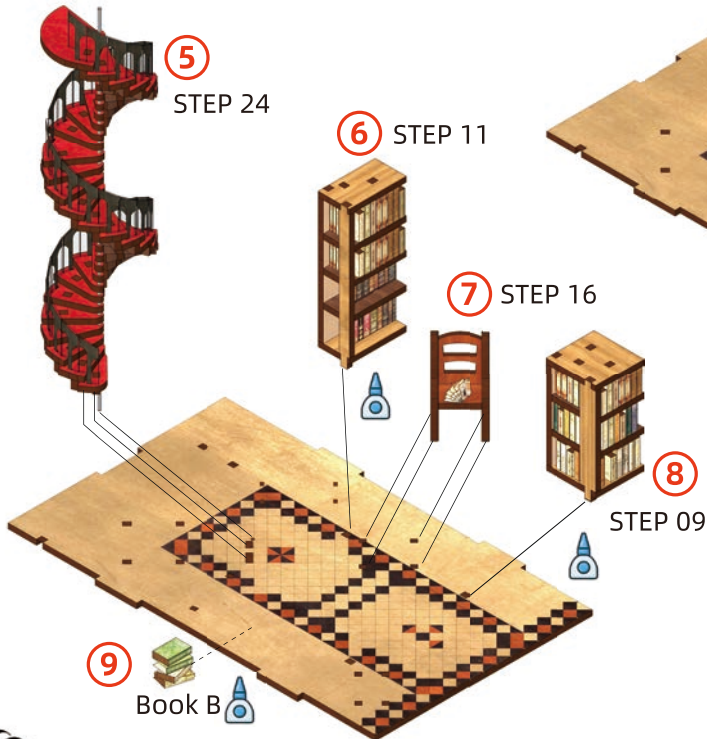

TIPS

Recommended to reinforce the fixing of all parts on the bottom board-I2 contact surfaces with glue.

各个部件和底板-I2的接触面建议用胶水加强固定





STEP 17

11



10

STEP 08

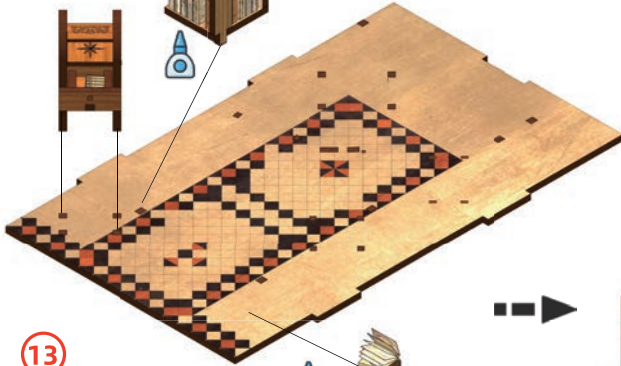

TIPS

Recommended to reinforce the fixing of all parts on the bottom board-I2 contact surfaces with glue.

各个部件和底板-I2的接触面建议用胶水加强固定。

13



Book B&Folding Book-A

12

2 pcs Paintings on J board can be placed freely.
J板上两个画可以自由摆放。

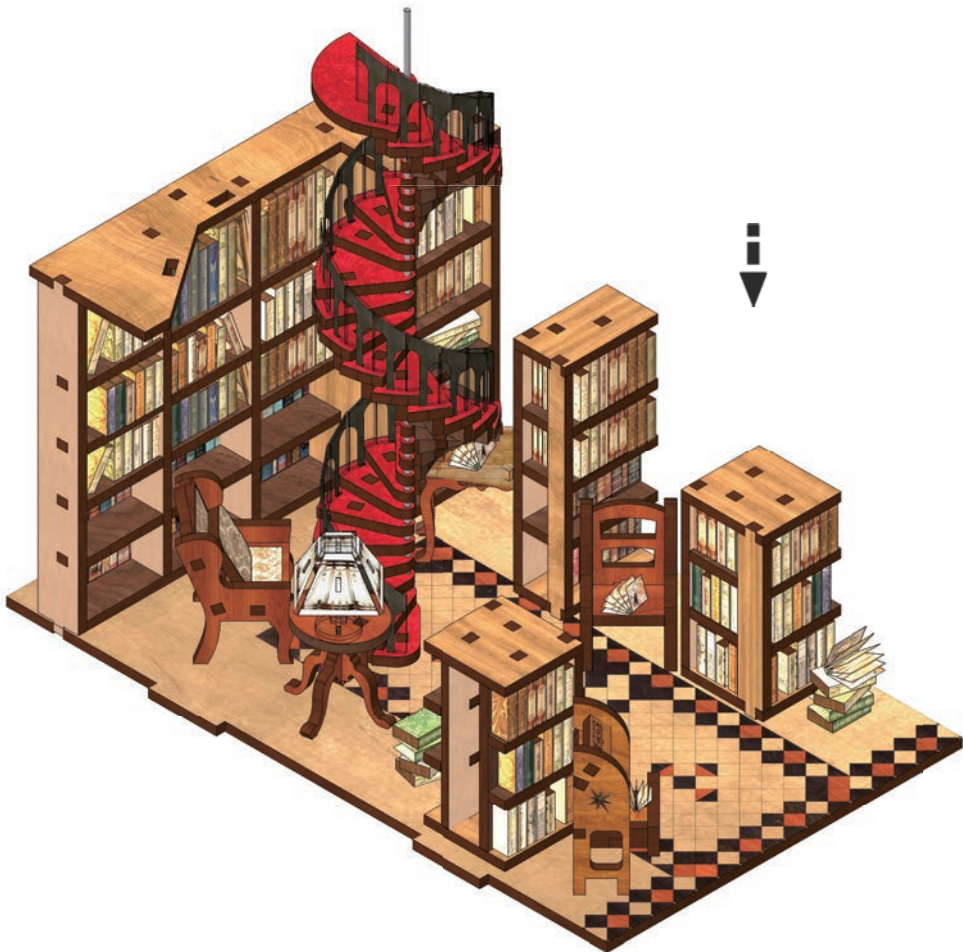
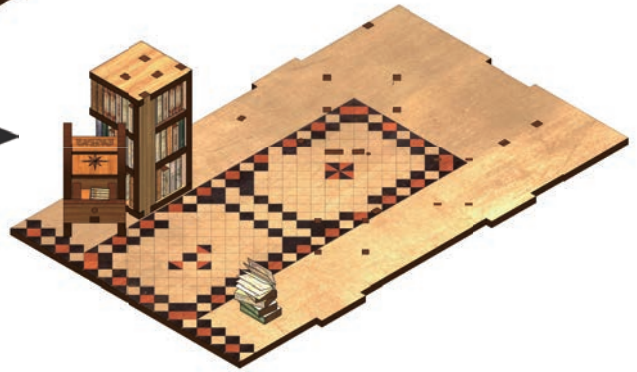

PART 2



TIPS

When installing part2, you can lay the entire E-board on the table horizontally to make it easier to be assembled. It is not necessary to place the individual boards in exactly the same direction as shown in the illustration.

安装part2的时候，可以将E板整个平放在桌上，这样更便于拼装。不需要完全按照图示方向摆放各个部件。

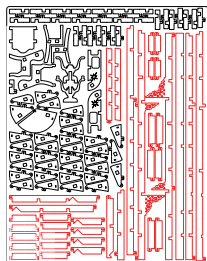

B

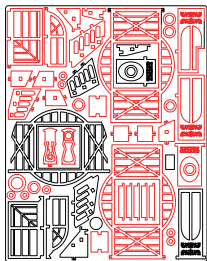

C

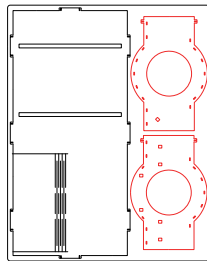

D

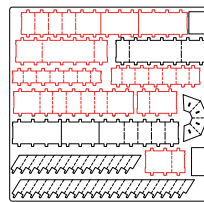

J

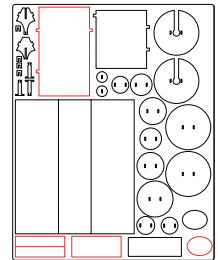

K

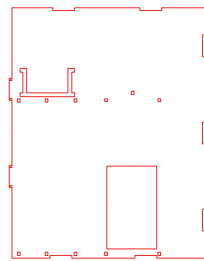

E

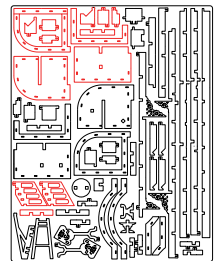

F

STEP 26

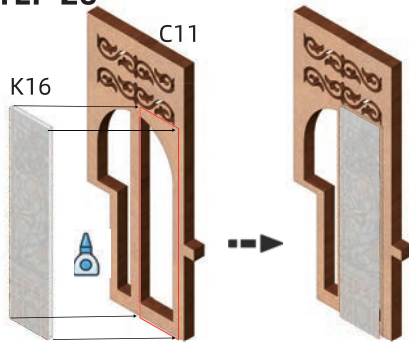

STEP 27

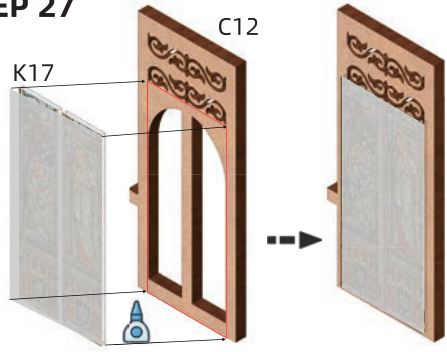

STEP 28

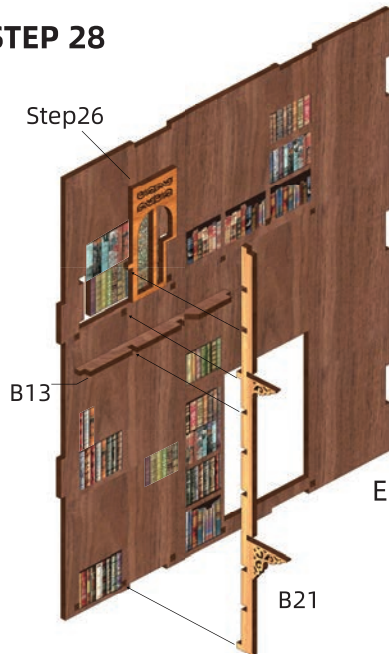

TIPS
Pay attention to the position of B13 preventing misdirection installation.
注意B13板的位置，预防颠倒安装。



STEP 29

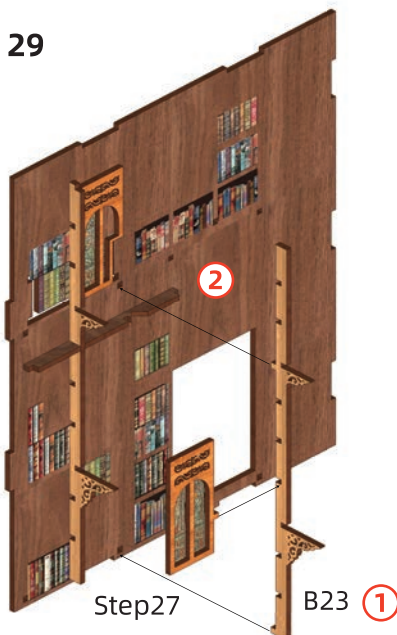

STEP 30



STEP 31

TIPS

Pay attention to the position of C4 and C3 preventing misdirection installation. C3, C4 are fixed with glue on the back.

注意C3, C4的位置, 预防颠倒安装. C3, C4背面用胶水固定。

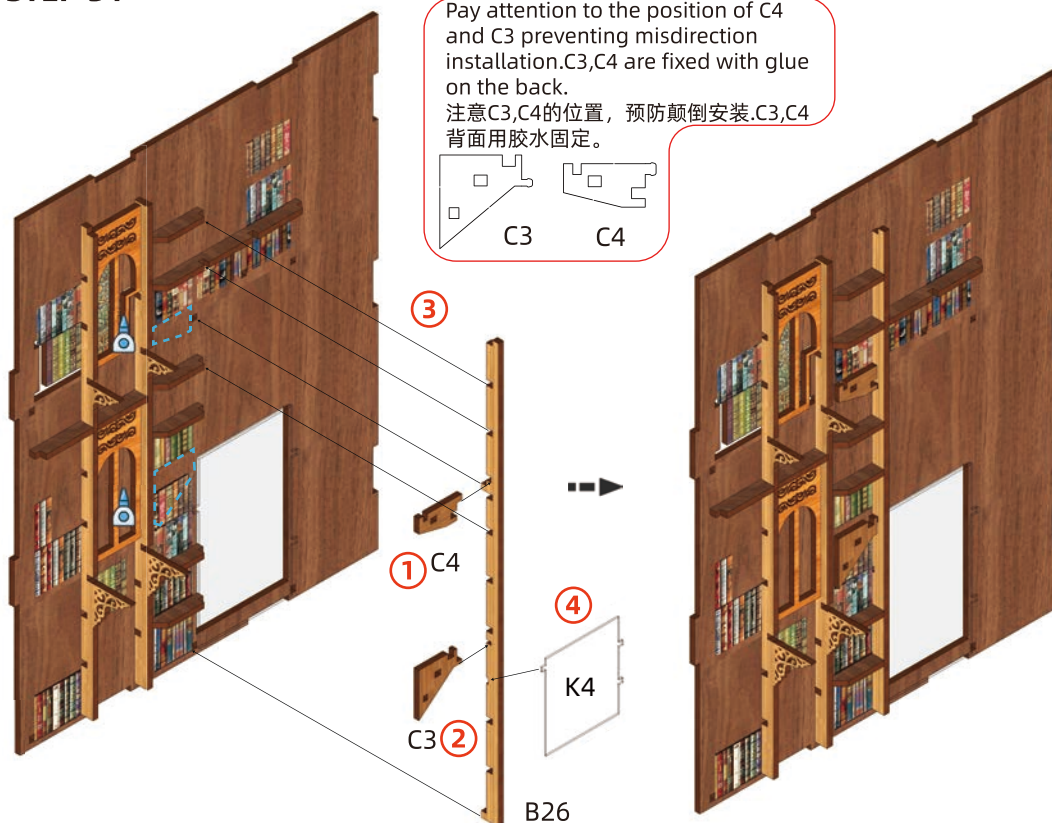
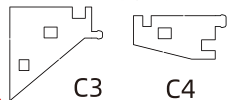

STEP 32

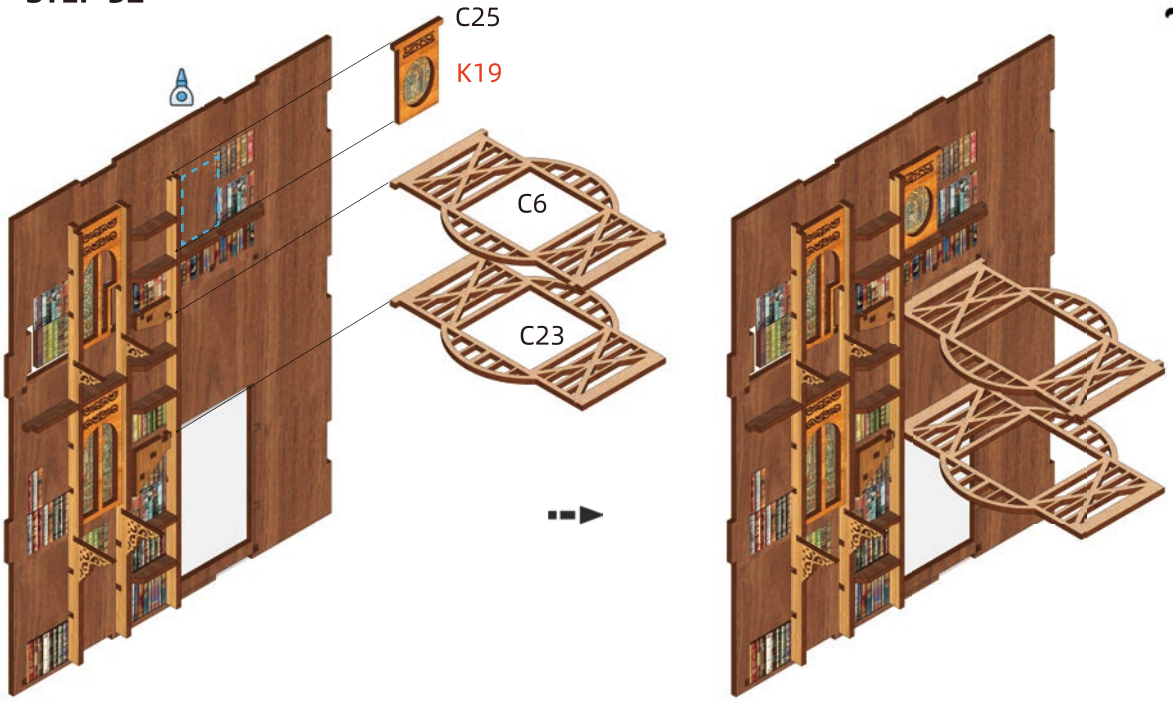

STEP 33

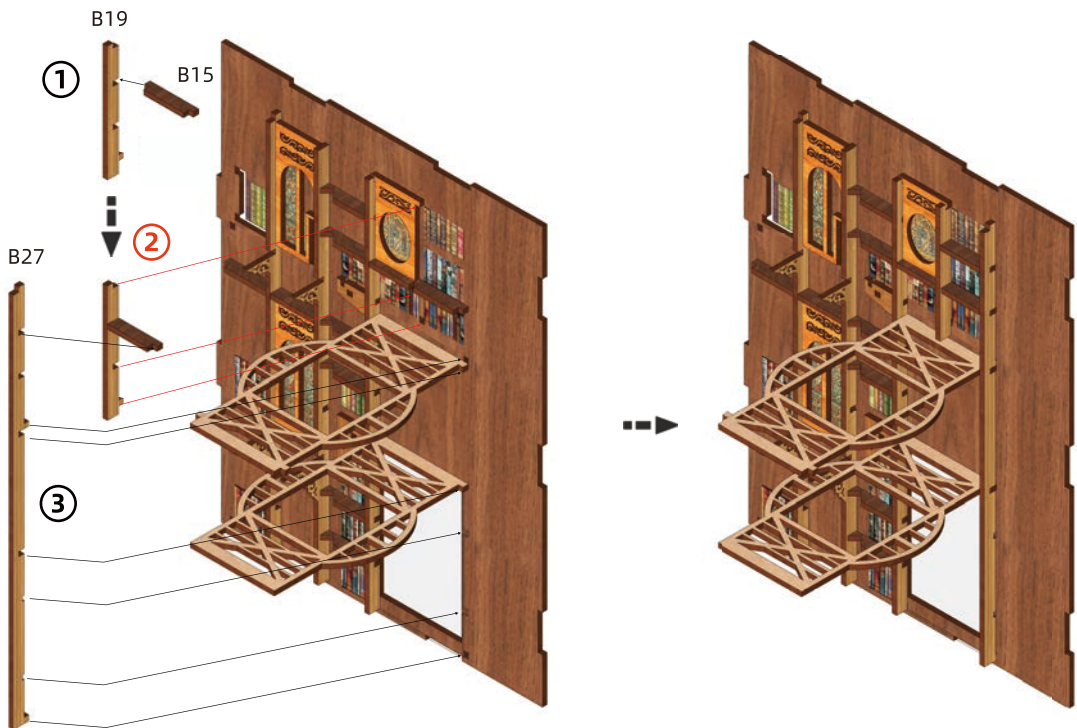

STEP 34

TIPS

Fasten B25 and the horizontal bookshelf against the beveled edge as shown in the diagram.
请靠着斜边固定B25和横向书架,位置关系如图所示

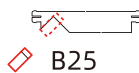

STEP 35

TIPS

Install all components in the direction of the arrows in the illustration.
按照图中箭头方向安装各个部件。

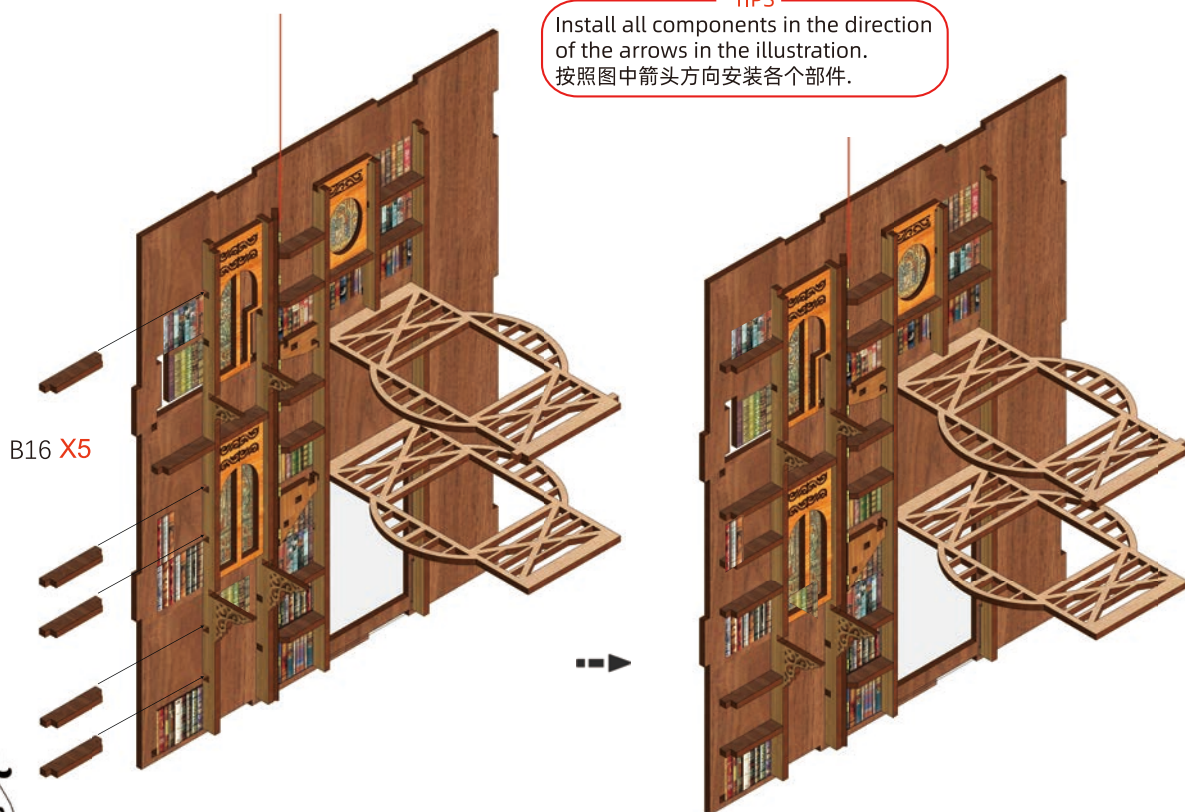

STEP 36

①

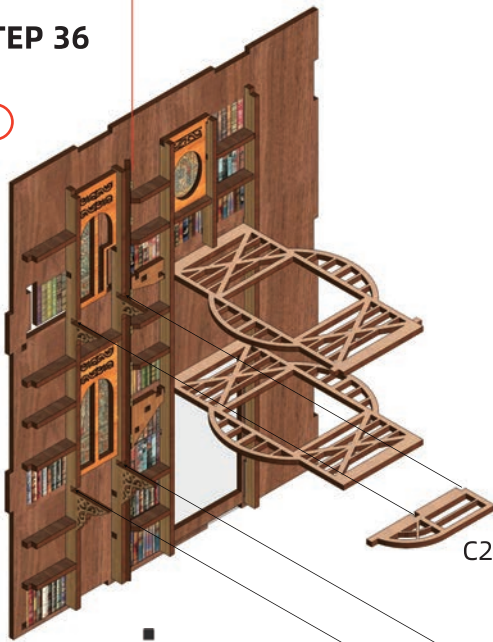

C2

②

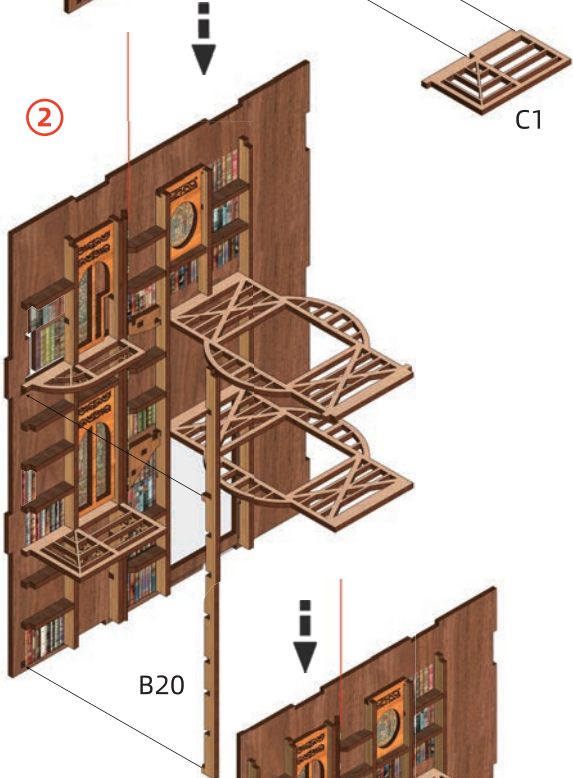

C1

B20

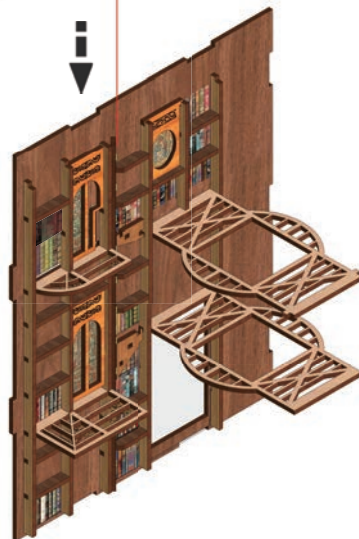

STEP 37

TIPS

Adding books where there is no book pattern on the E-board. Notice that the red box in the picture needs to be purposely left empty. 在E板没有书图案的地方添加立体书，注意图中红框部分需要特意空着。

Book Making refer to page 5
书本制作参考第五页

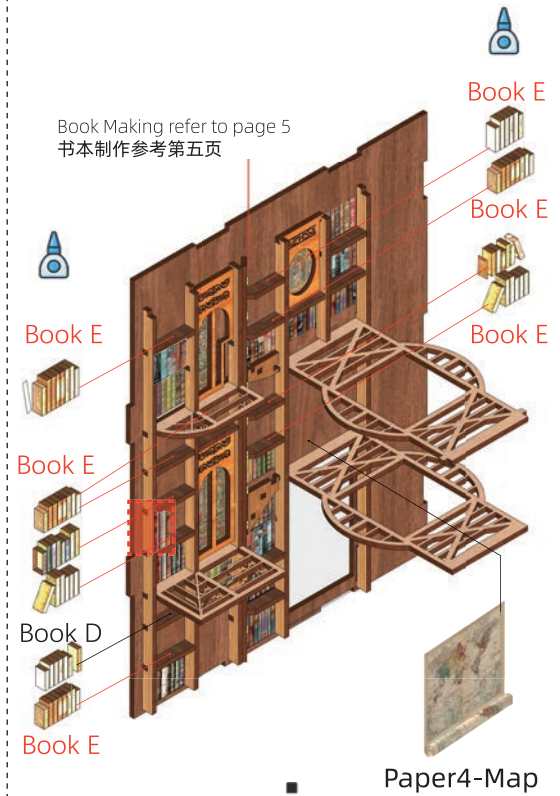

Book E

Book E

Book E

Book E

Book E

Book D

Book E

Paper4-Map

STEP 38

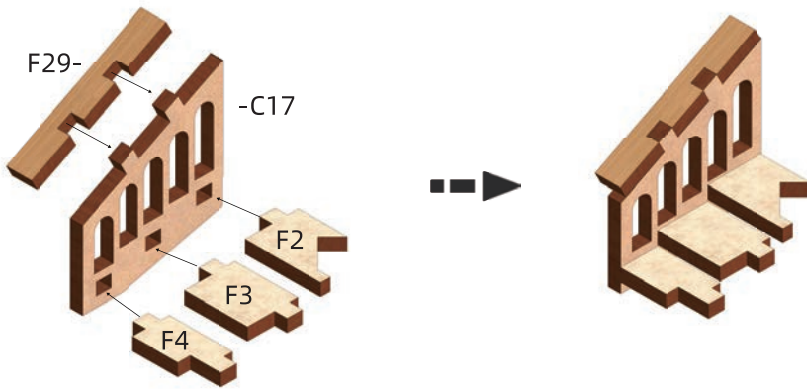

TIPS

Please note that the F29 is the front side up.
注意F29正面朝上

STEP 39

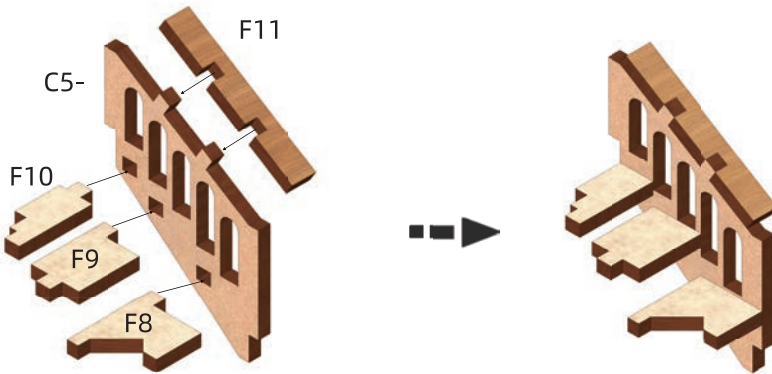

TIPS

Please note that the F11 is the front side up.
注意F11正面朝上

STEP 40

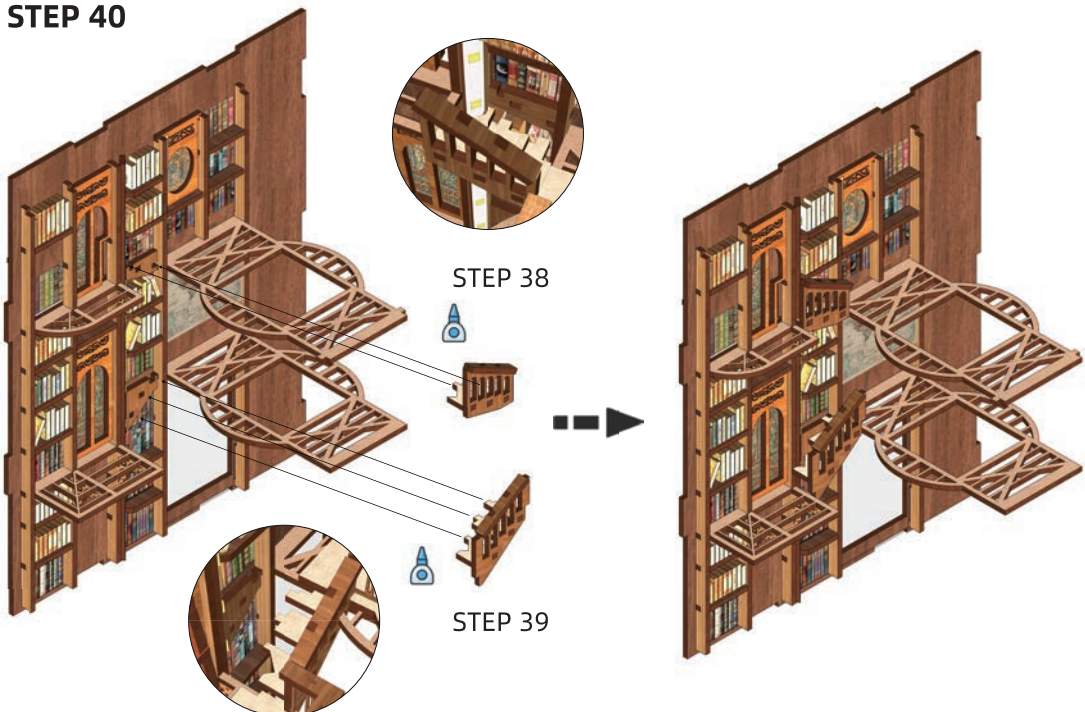

STEP 41

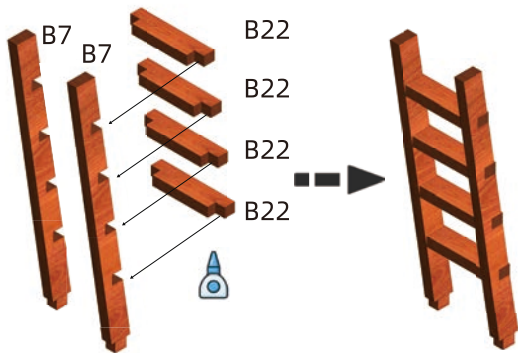

STEP 42

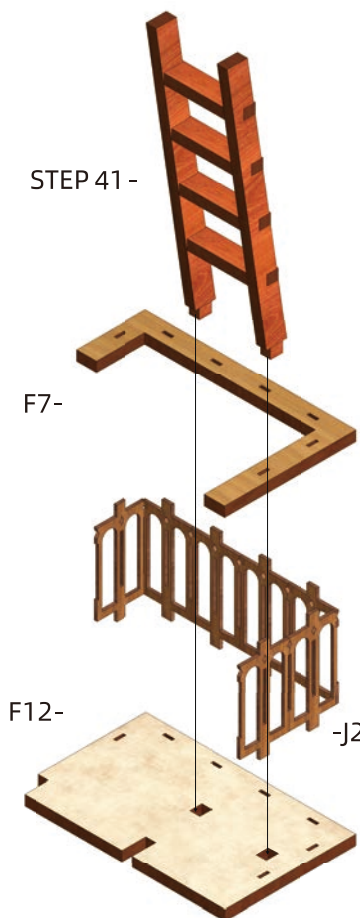

TIPS
Remove the plastic layer on the front of the J2 before installation.
安装前请撕掉J2正面的塑料薄膜

STEP 43

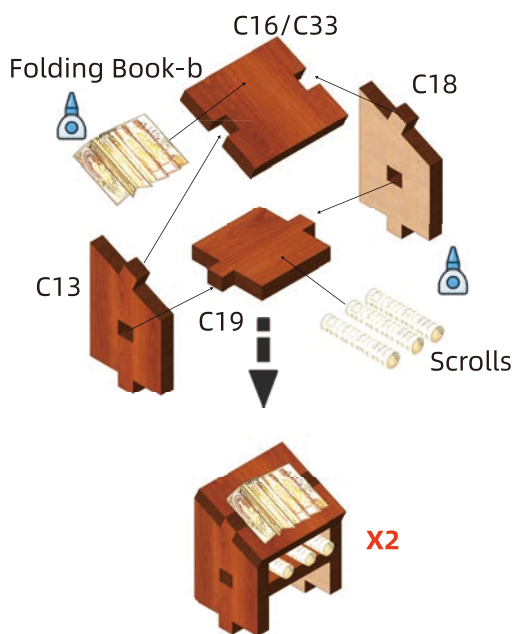

STEP 44

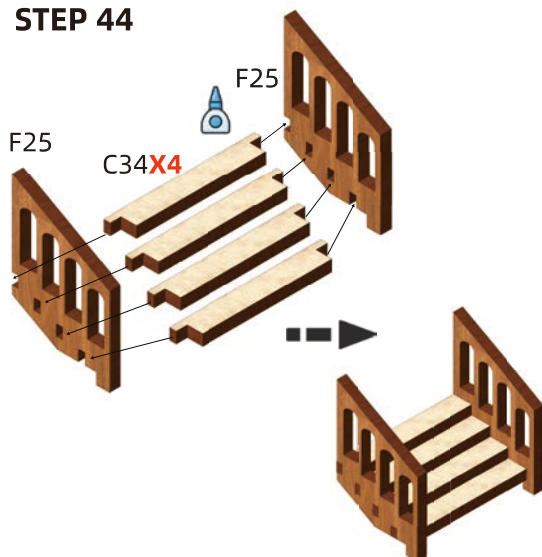

STEP 45

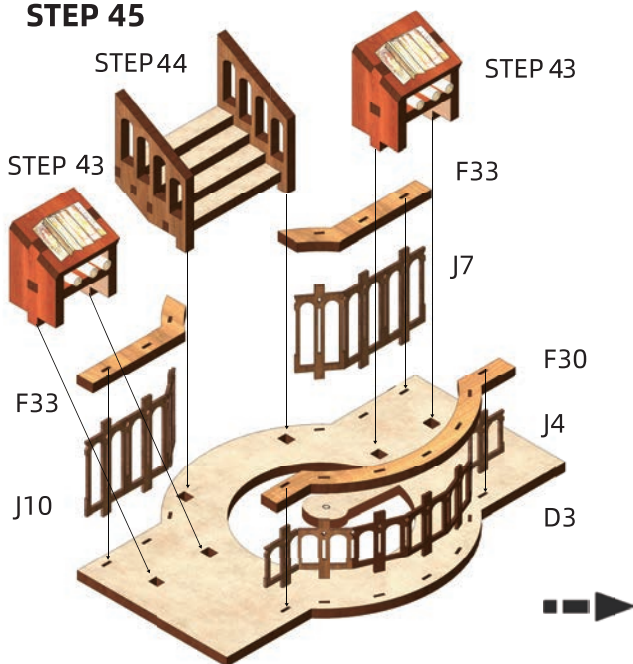

- TIPS**
1. Please note that the F30 & F33 is the front side up.
注意F30&F33正面朝上
 2. Remove the plastic layer on the front of the J4, J7 and J10 before installation.
安装前请撕掉J4, J7和 J10 正面的塑料薄膜



STEP 46

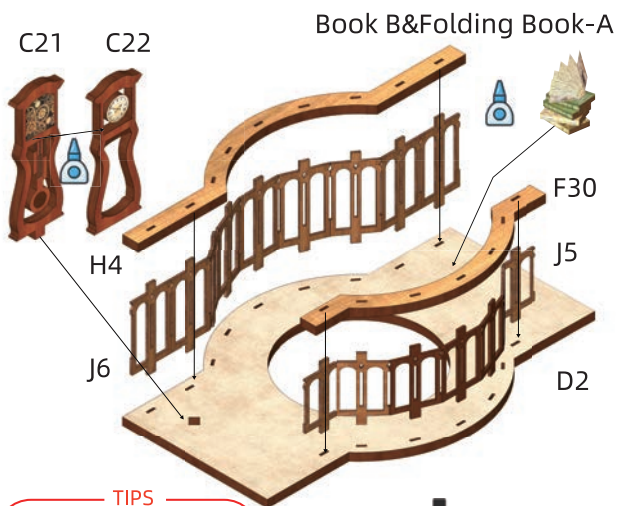

- TIPS**
1. Please note that the F30 is the front side up.
注意F30正面朝上
 2. Remove the plastic layer on the front of the J5 & J6 before installation.
安装前请撕掉J5和J6 正面的塑料薄膜



STEP 47

- TIPS**
- The J1 can be disassembled into three pieces, 2 pieces are used here and the remaining piece is installed at STEP 49. J1 can be disassembled into three pieces, here using 2 pieces, the remaining one is installed at step 49.

- TIPS**
- The back of this J1 is facing forward and the other J1s are facing front.
注意这块J1背面朝前，其他J1正面朝前。



STEP 48

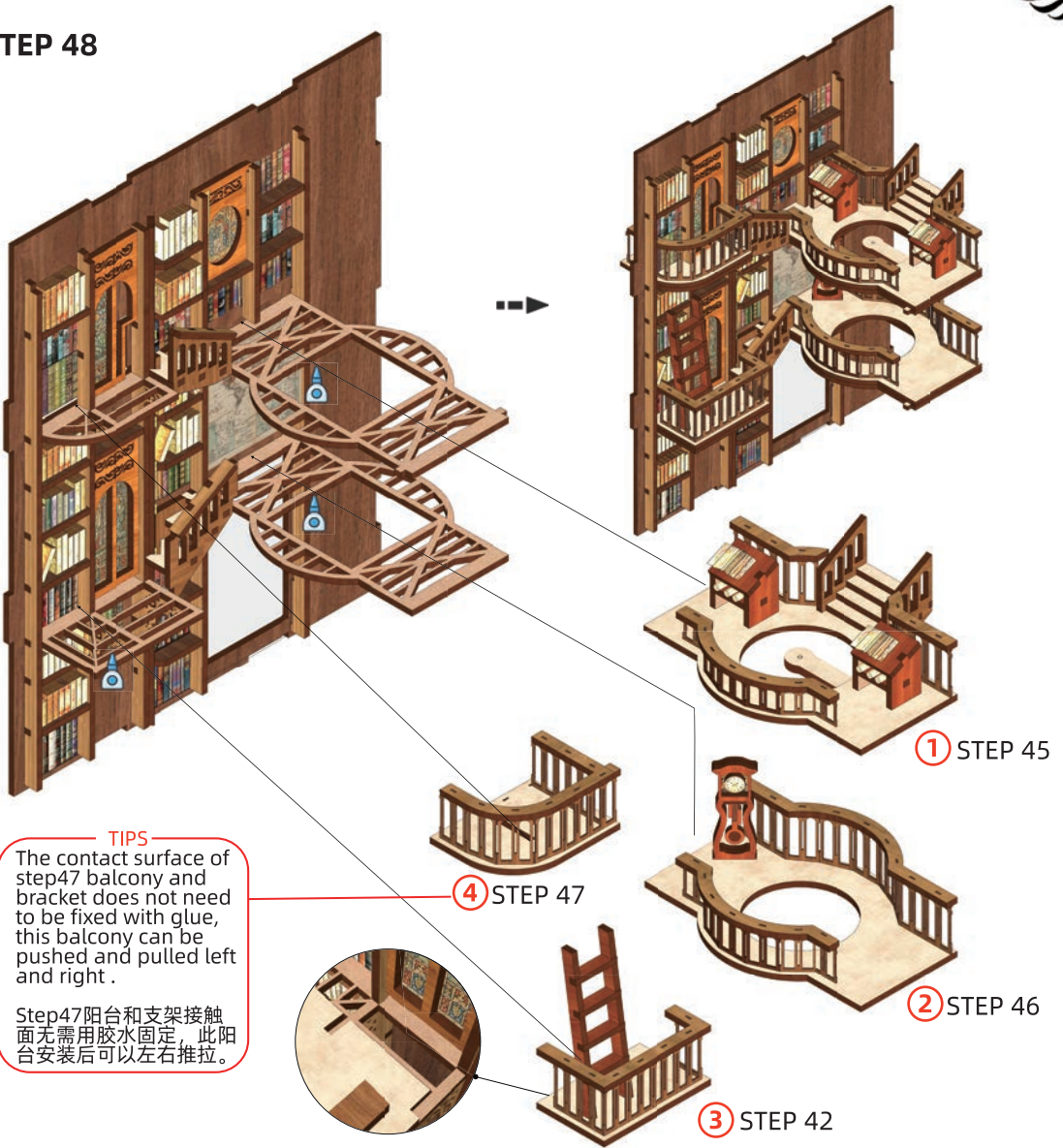

STEP 49

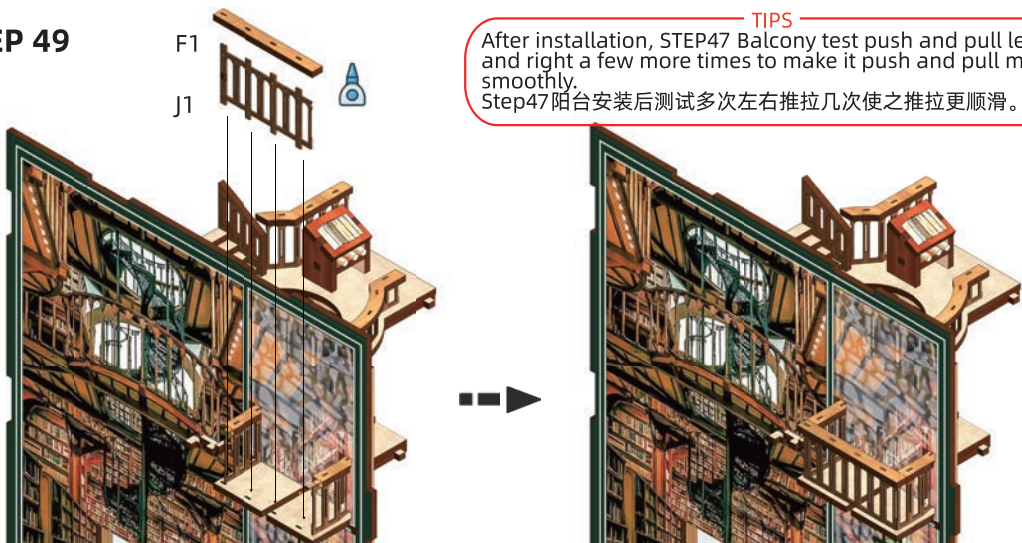

PART 3

TIPS

When installing part3, you can lay the entire G-board on the table horizontally to make it easier to be assembled. It is not necessary to place the individual boards in exactly the same direction as shown in the illustration.

安装part3的时候，可以将G板整个平放在桌上，这样更便于拼装。不需要完全按照图示方向摆放各个部件



G

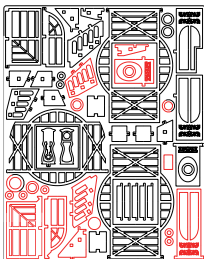

C

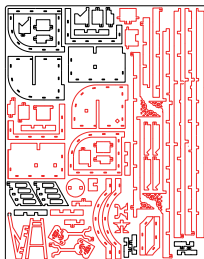

F

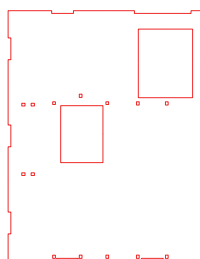

G

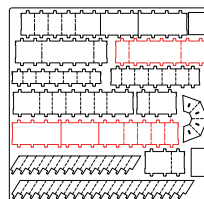

J

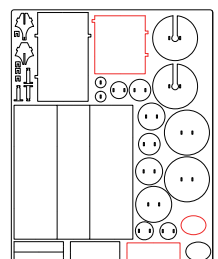

K

STEP 50

①
F44



G

②

B15 X4

K5

C9
K19



STEP 51

①

F41

F42

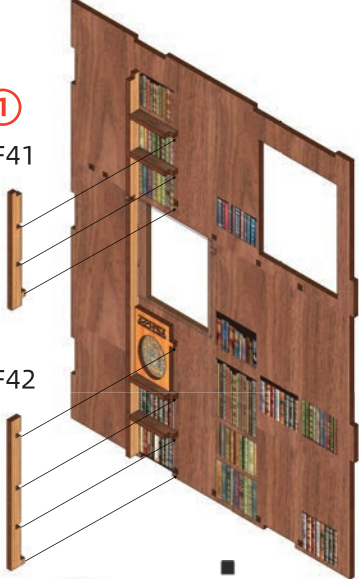

②

C35 K18



②



STEP 52

①

F45

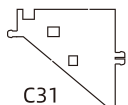
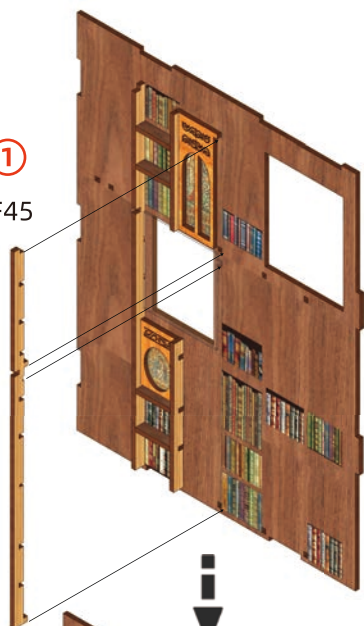

B24X6

②



C8

C31



TIPS

Pay attention to the position of C8 and C31 preventing misdirection installation. C8, C31 are installed on the right side of F45. 注意C8, C31的位置, 预防颠倒安装. C8, C31安装在F45

STEP 53

①

F43

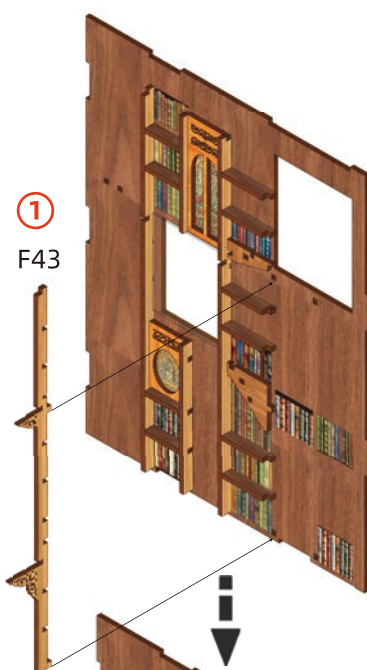

②

Paper4
Calendar

B18



STEP 54

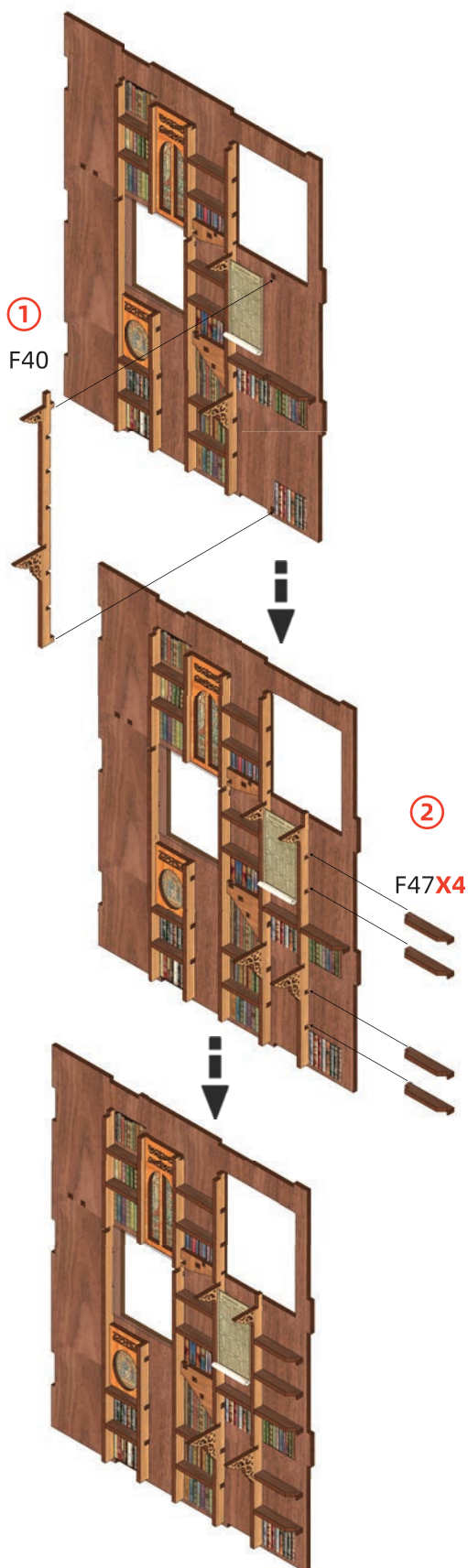

STEP 55

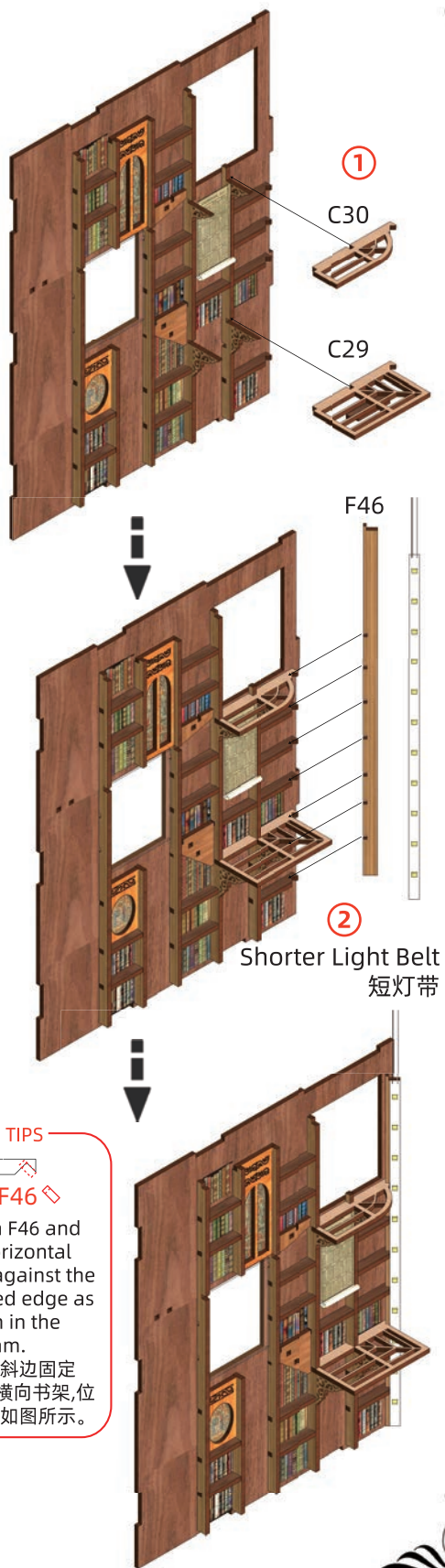

TIPS

F46

Fasten F46 and the horizontal shelf against the beveled edge as shown in the diagram.
请靠着斜边固定 F46和横向书架,位置关系如图所示。

STEP 56

BOOK E

BOOK E & D

BOOK E

TIPS

Adding books where there is no book pattern on the E-board. Notice that the red box in the picture needs to be purposely left empty. 在E板没有书图案的地方添加立体书, 注意图中红框需要特意空着。

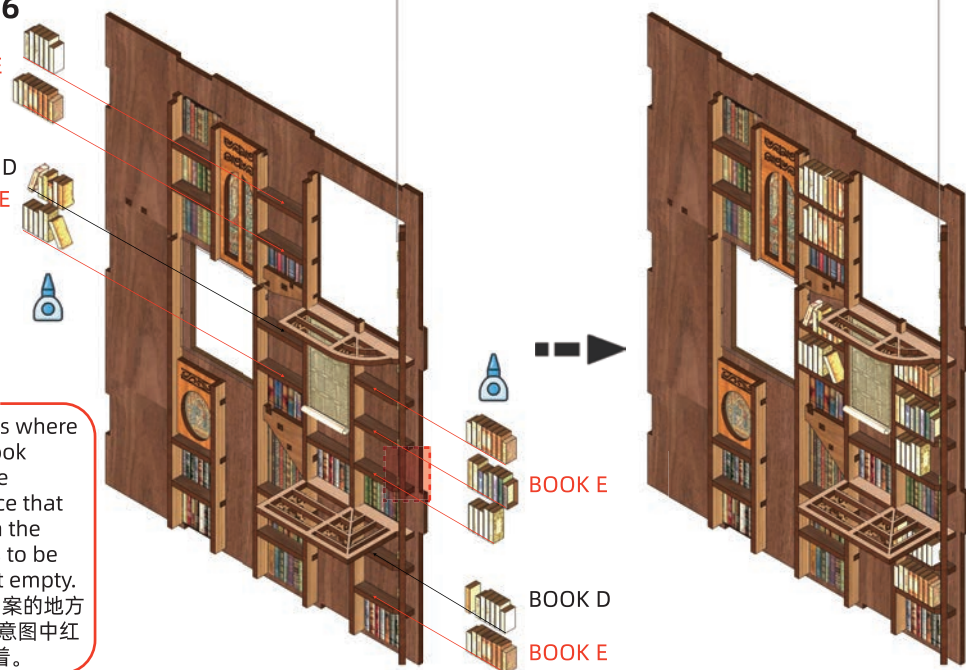

STEP 57

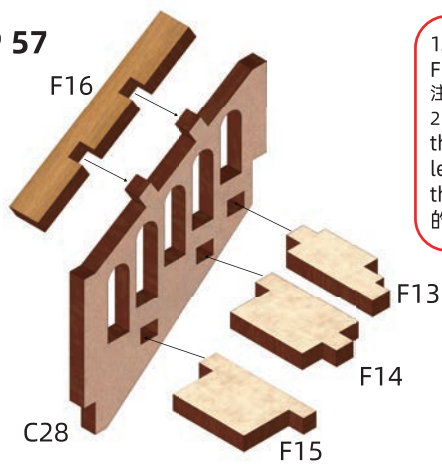

TIPS

1. Please note that the F16 is the front side up. 注意F16正面朝上。
2. Note the position of the F15 to prevent left-right reversal of the installation. 注意F15的位置, 预防颠倒安装。



STEP 58

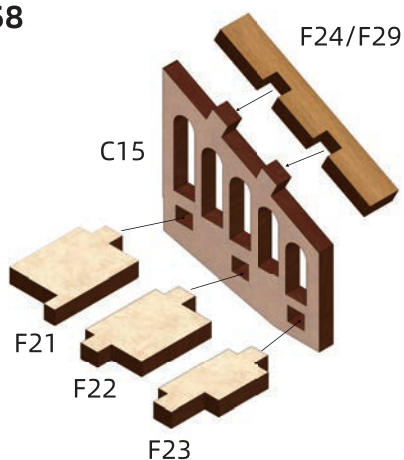

TIPS

Please note that the F24/F29 is the front side up. 注意F24/F29正面朝上。



STEP 59

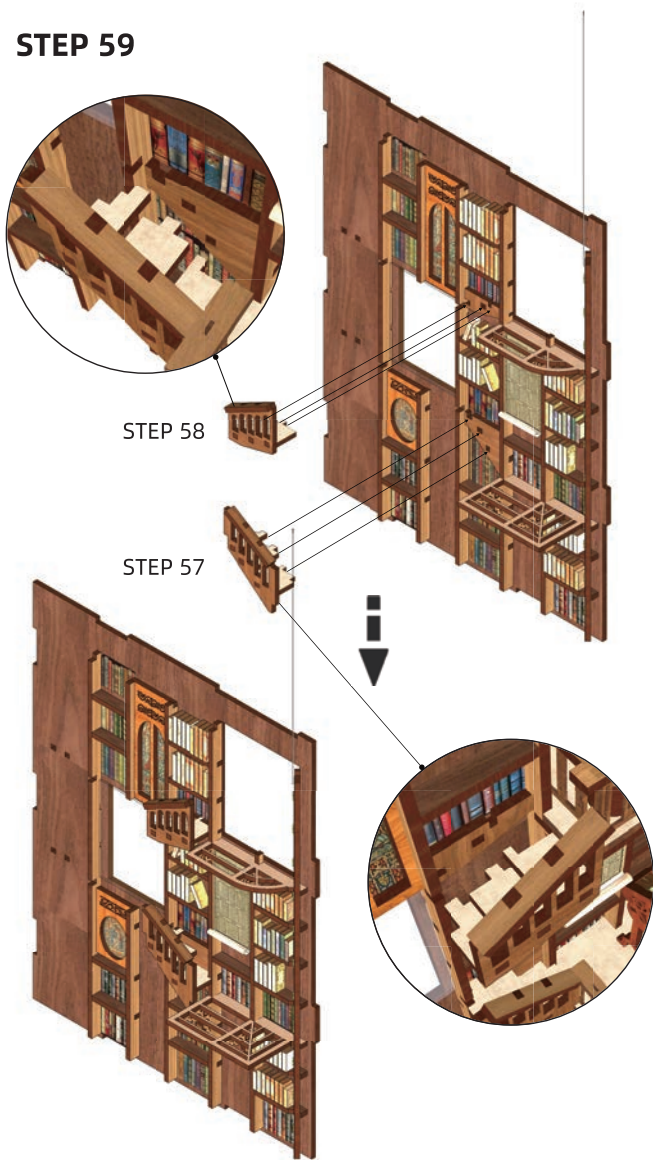

STEP 61

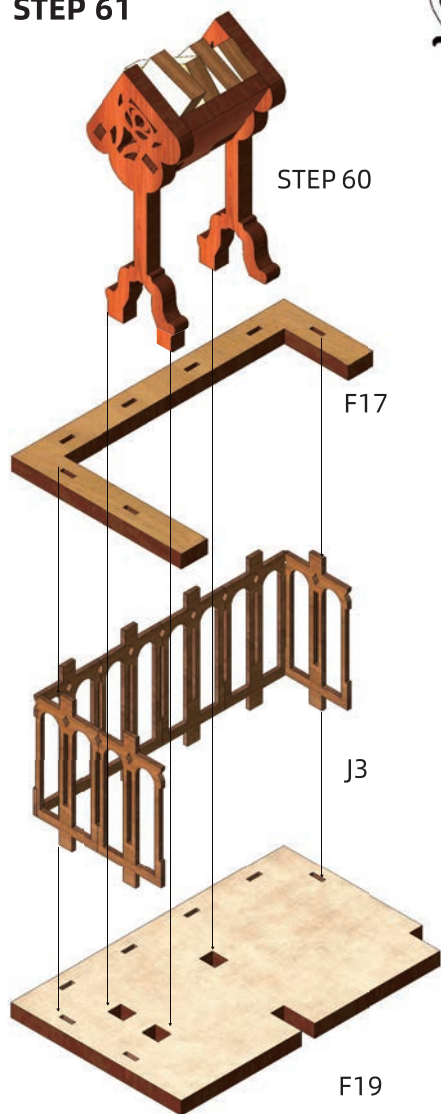

STEP 60

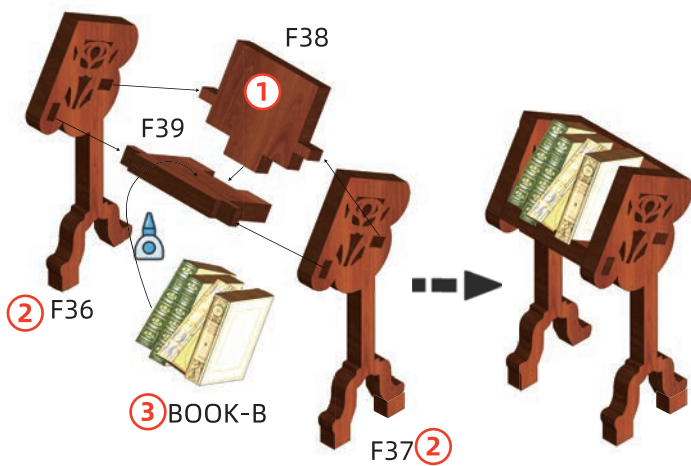

TIPS
Remove the plastic layer on the front of the J3 before installation.
安装前请撕掉J3正面的塑料薄膜

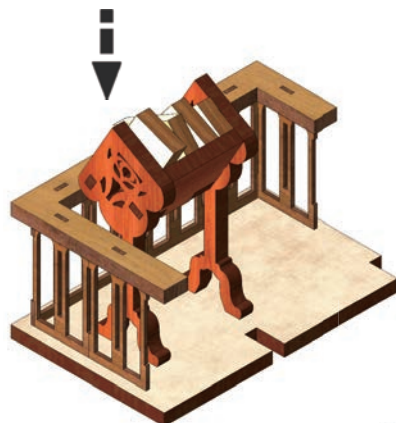

STEP 62

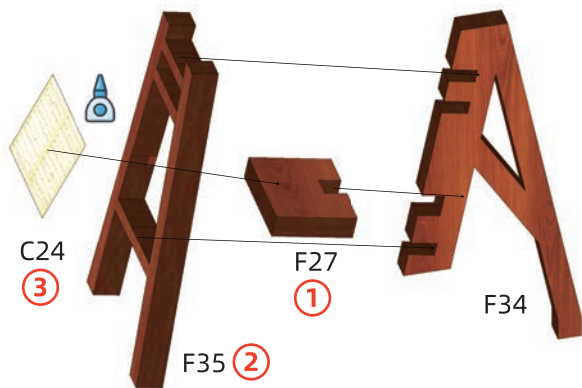

TIPS
Install the easel in the order of the numbers in the red box, C24 needs to be set over F27 stuck in F35
按红框数字顺序安装画架, C24需要套过F27卡在F35



STEP 63

Paper4 - Rolling paper

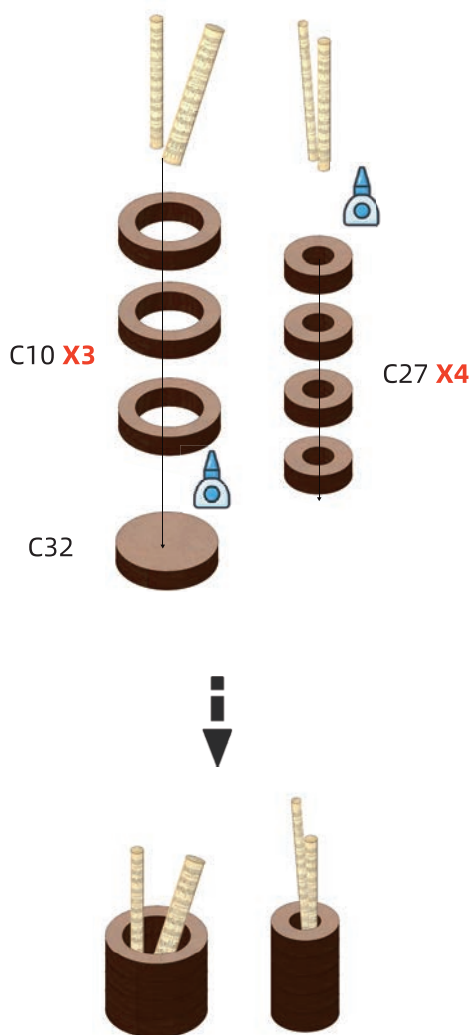

STEP 64

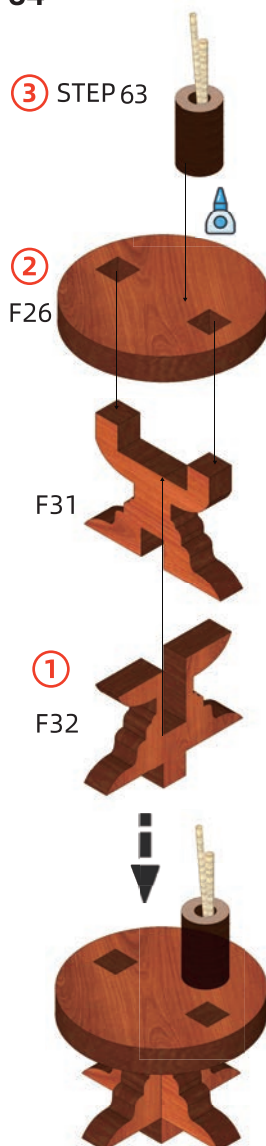

STEP 65

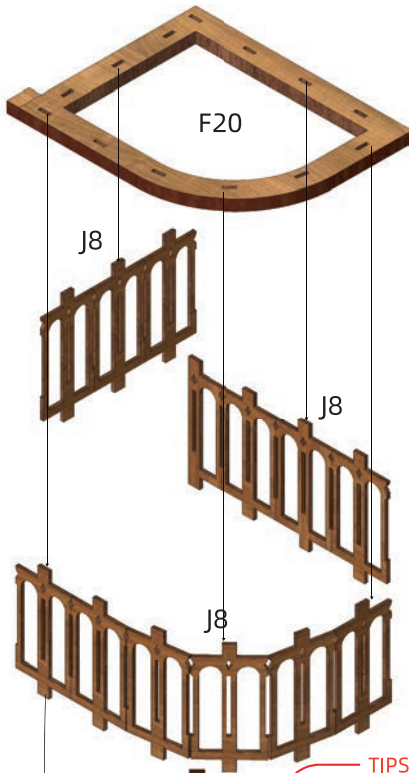

TIPS
Remove the plastic layer on the front of the J8 before installation.
安装前请撕掉J8正面的塑料薄膜

STEP 62

STEP 63

STEP 64

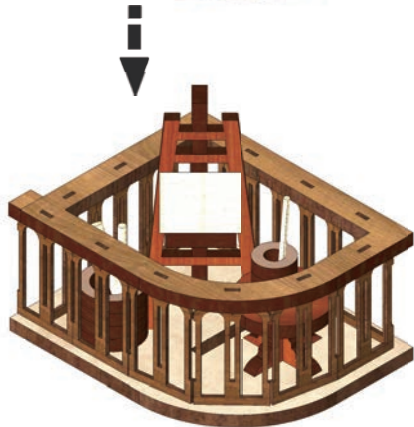
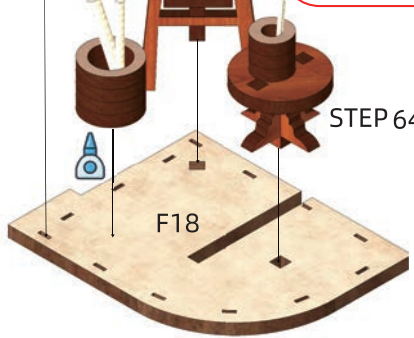

STEP 66

TIPS
After installation, STEP 65 Balcony test push and pull left and right a few more times to make it push and pull more smoothly.
Step65阳台安装后测试多次左右推拉几次使之推拉更顺滑。



STEP 67

PART 2

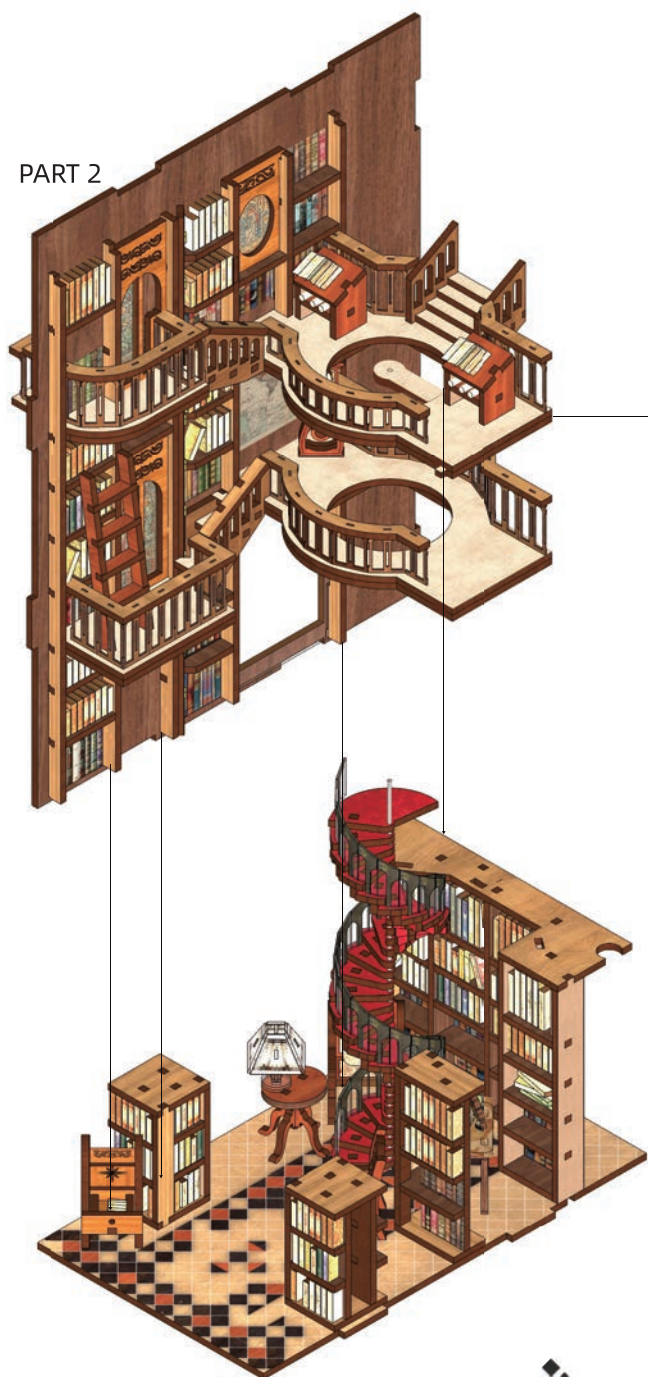

PART 1

TIPS

Note to its part2 vertical bookshelf versus the bookshelf and rotating staircase in part1. Please try to pair it.

注意对其part2竖向书架与part1中的书架和旋转楼梯。请尽量对其。

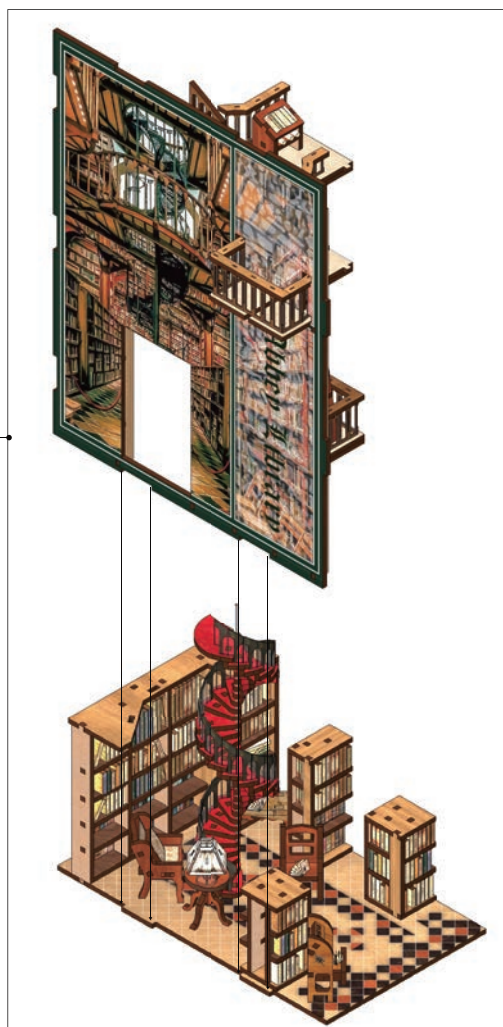

STEP 68



① Battery box
电池盒

TIPS
except LIGHT1 (red cable) Branches of cable are placed above the board through round holes in the bookcase, and the main cable is placed below the board.
除了Light1(红线), 所有电线的分支穿过书架上圆洞置于板上方, 总线置于板下方。

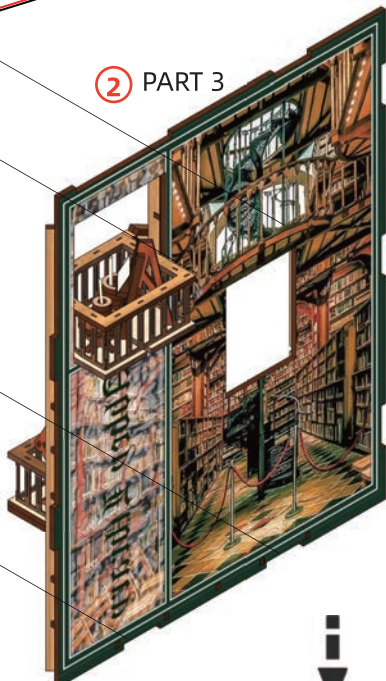

② PART 3

TIPS
Apply glue to the slot for installing the rotating staircase balcony in part2 before putting it together in part2 and part3.
Part2和part3拼装前先给part3里安装旋转楼梯阳台的卡槽涂上胶水。



PART 4

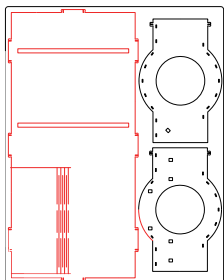

D

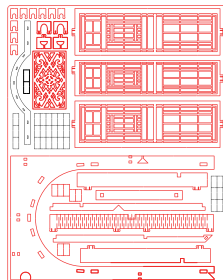

H

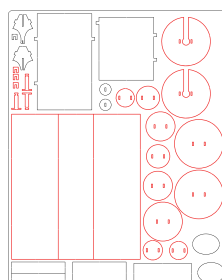

K

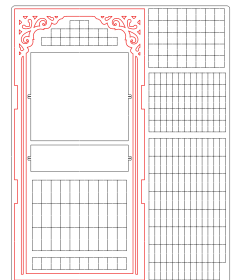

L

STEP 69

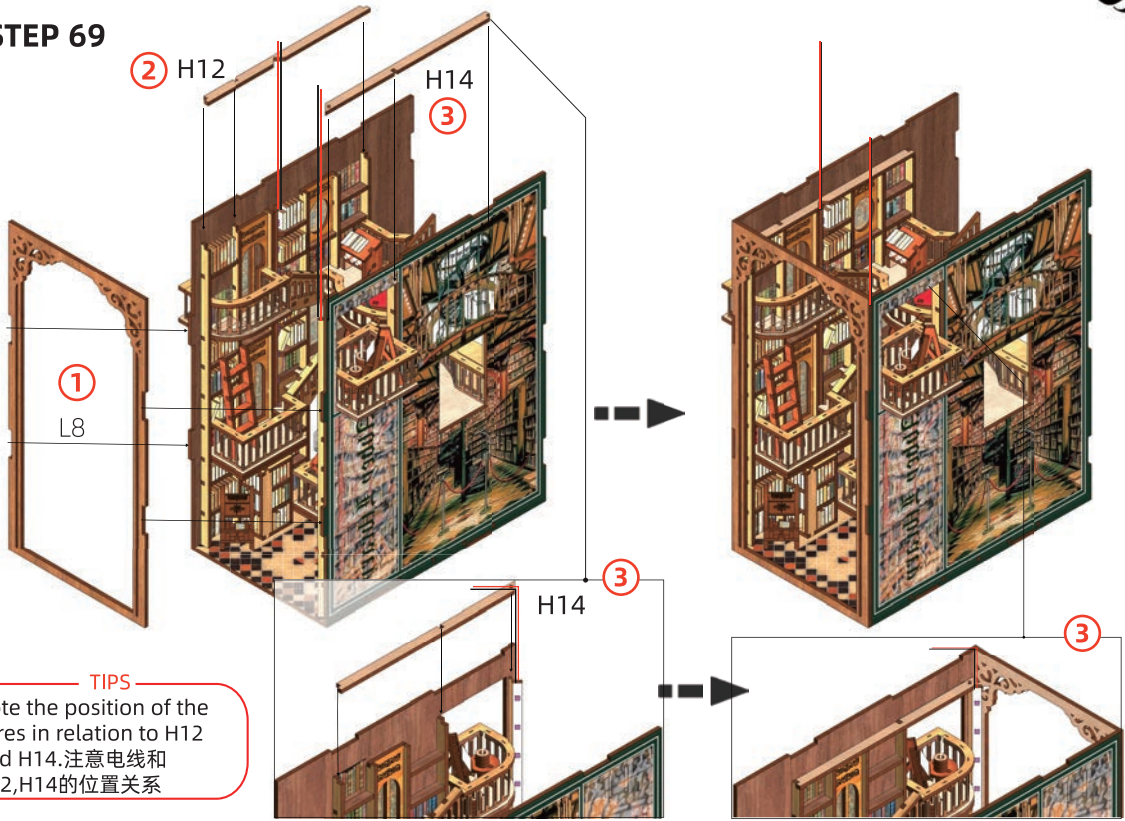

STEP 70

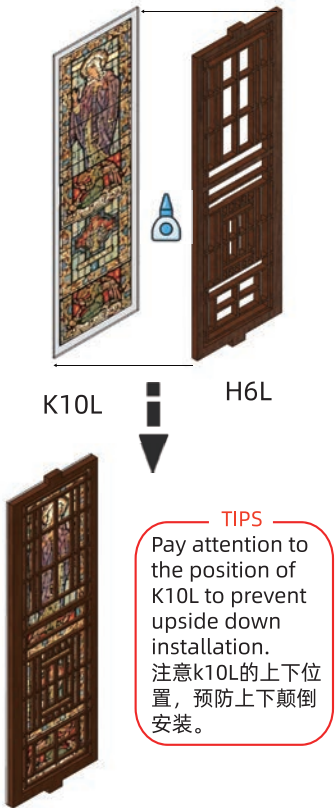

STEP 71

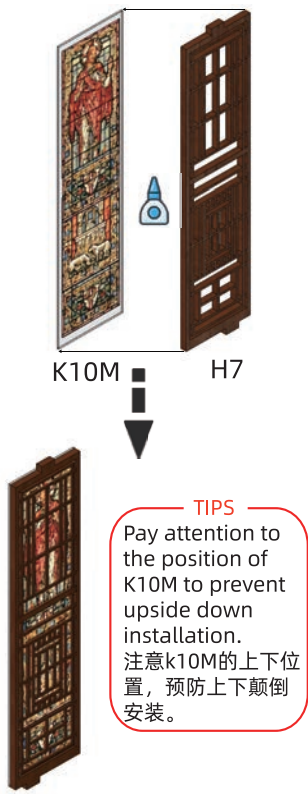

STEP 72

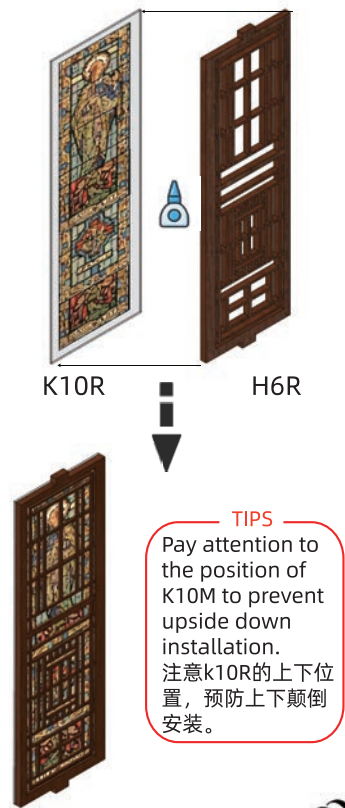

STEP 73

TIPS

If the step70-72 snaps won't fit into the slots, use an abrasive tool to thin out their snaps rather than pressing them in hard leading to the whole assembly falling apart!
如果step70-72卡扣无法塞进卡口中, 请用磨砂工具打薄其卡扣, 而不是用力压进去导致整体散架

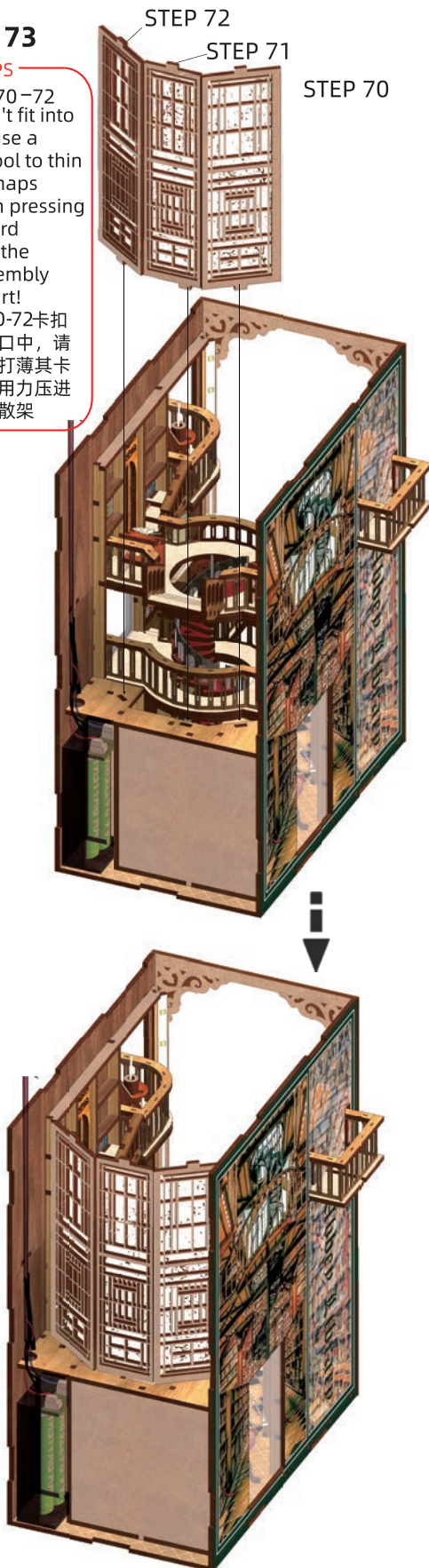

STEP 74

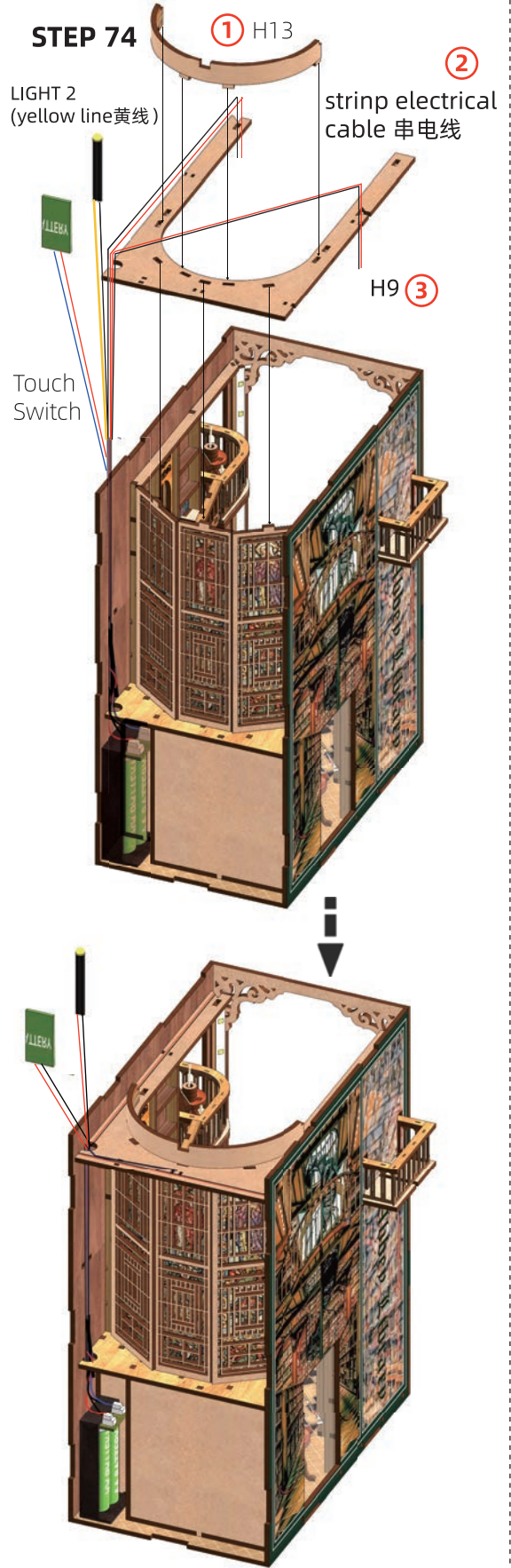

STEP 75

H1 X4-



TIPS

If H1 is unable to fully secure the cables to the board, they can be attached with stickers.
如果H1无法完全把电线固定在板上，可以用贴纸固定



Stickers



STEP 76

H1 -

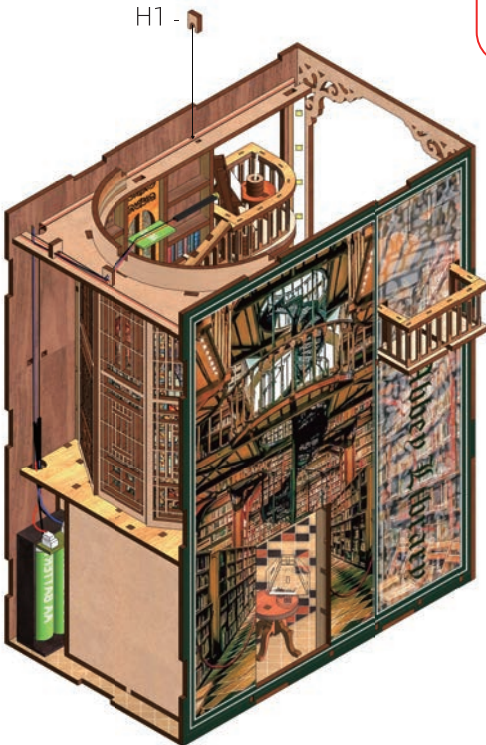

TIPS

If H1 is unable to fully secure the cables to the board, they can be attached with stickers.
如果H1无法完全把电线固定在板上，可以用贴纸固定



Stickers

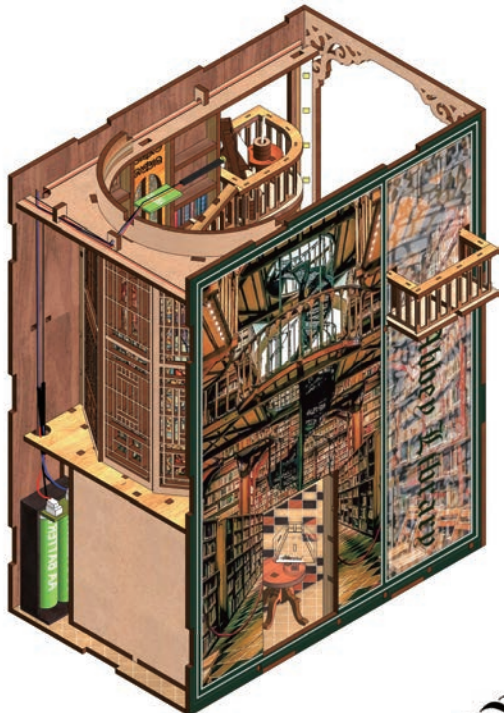

STEP 77

TIPS

If the H10 and H15 snaps won't fit into the slots, use an abrasive tool to thin out their snaps rather than pressing them in hard leading to the whole assembly falling apart!

如果H10和H15卡扣无法塞进卡口中，请用磨砂工具打薄其卡扣，而不是用力压进去导致整体散架

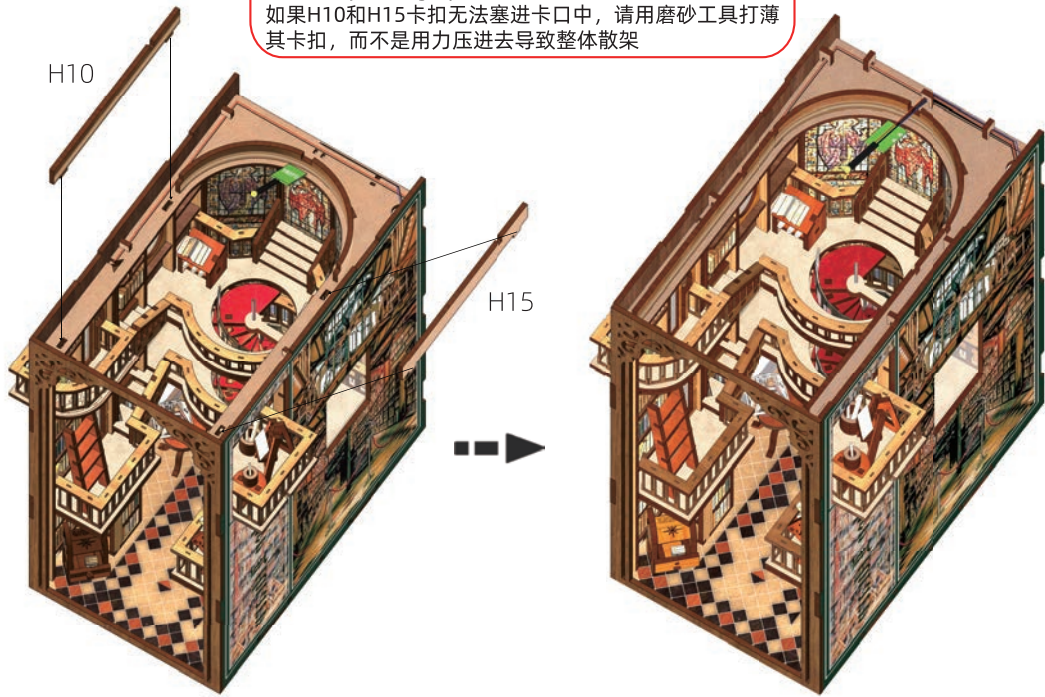

STEP 78

TIPS

The touch switch and light 2 are located in the upper part of C26 and the contact surface of C26 with the curved board H13 is glued up.

触碰开关和light 2位于C26上部，C26与弧形板H13的接触面用胶水粘起来。

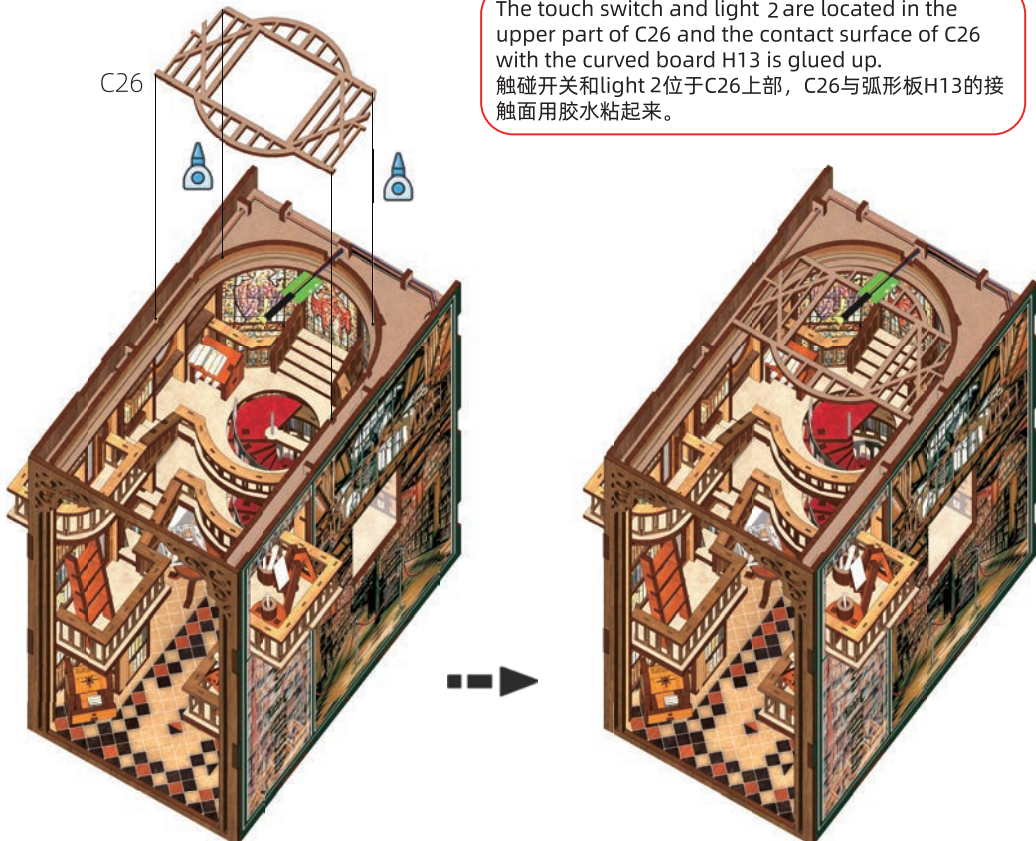

STEP 79

TIPS
Remove the plastic layer on the front of the K boards before installation.
安装前请撕掉K板正面的塑料薄膜

Bend the light bead by 90 degrees and place the light vertically downward into the reserved space of the K board.
将灯珠弯折90度，灯光垂直朝下放进到K板预留空隙中

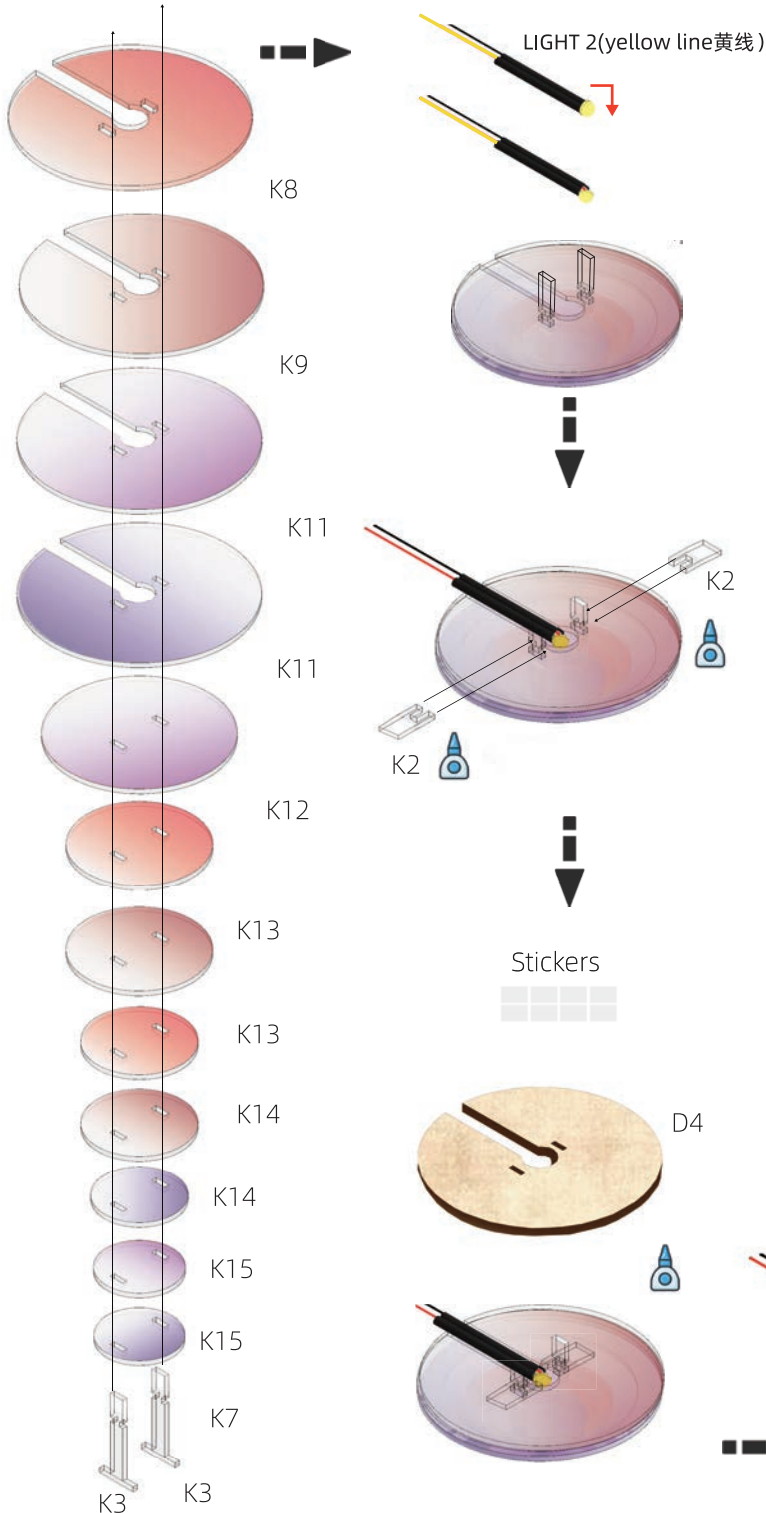

STEP 80

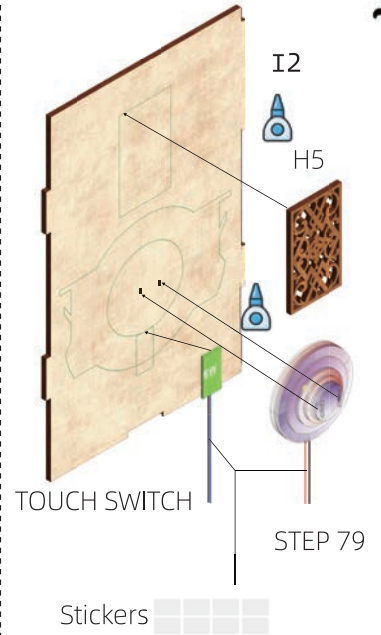

TIPS
Fixing cables and light with stickers
用贴纸固定电线和灯



STEP 81

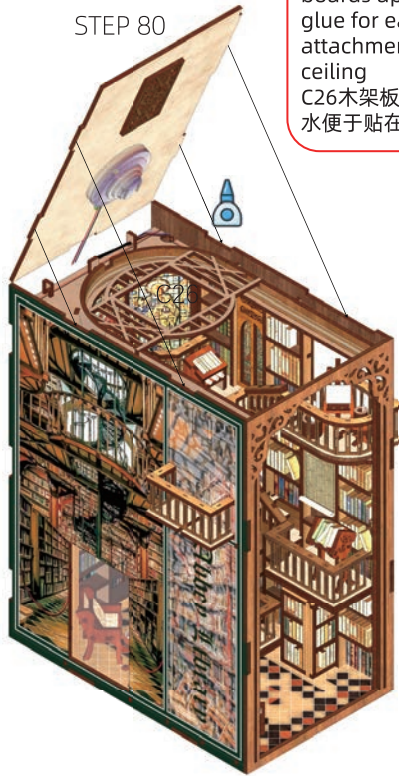

TIPS
C26 wooden frame boards applied with glue for easy attachment to the ceiling
C26木架板上涂上胶水便于贴在天花板上



STEP 82

TIPS
Remove the protective film from both the front and back sides before assembling.
拼装前撕掉正反两面保护膜。



STEP 83



Stickers

LIGHT 1 (red line 红线)



TIPS

Bend the Light 1 head at 90 degrees to the wire so that the head snaps right into the round hole and secure it with a sticker.
将Light4的灯头弯成与电线呈90度状态让灯头正好卡在圆孔上，并用贴纸固定

STEP 84

TIPS

If H2 is unable to fully secure the cables to the board, they can be attached with stickers.
如果H2无法完全把电线固定在板上，可以用贴纸固定

Stickers

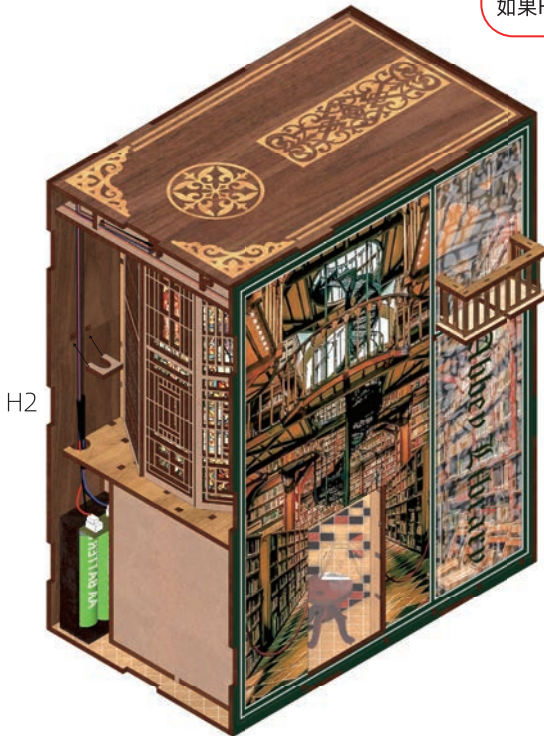

H2



STEP 85

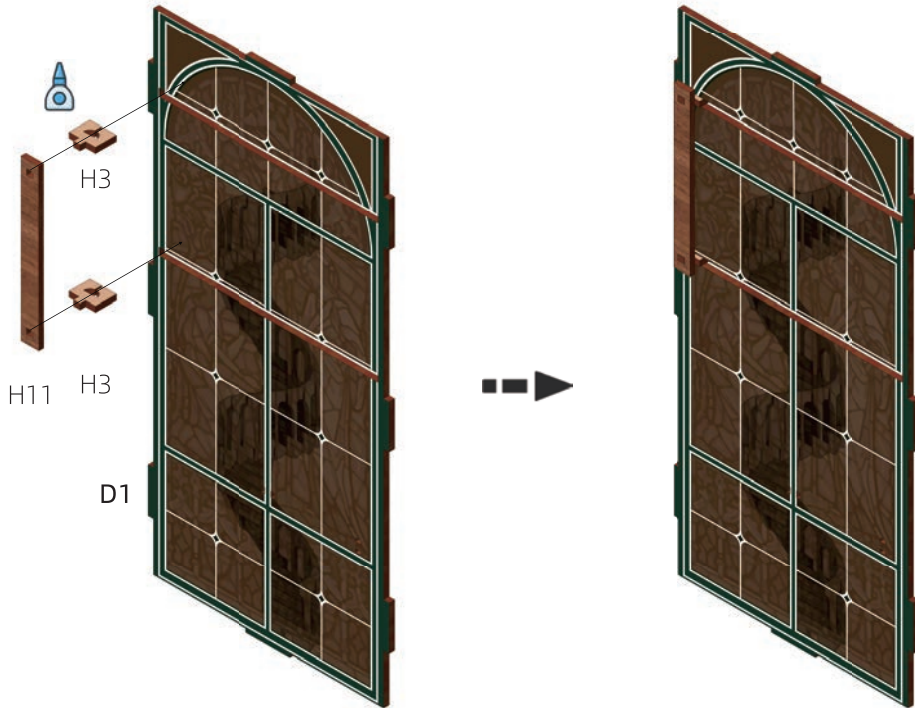

STEP 86

LIGHT 4 (green line 绿线)

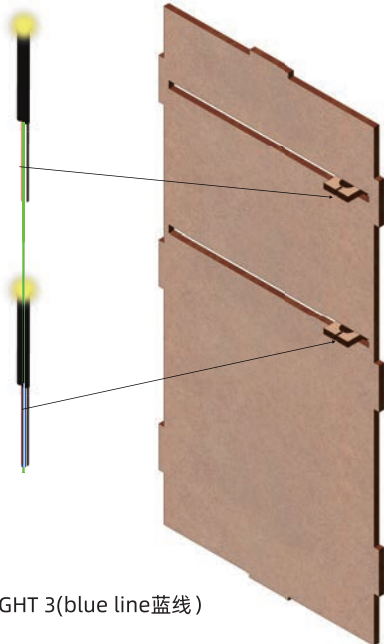

LIGHT 3 (blue line 蓝线)

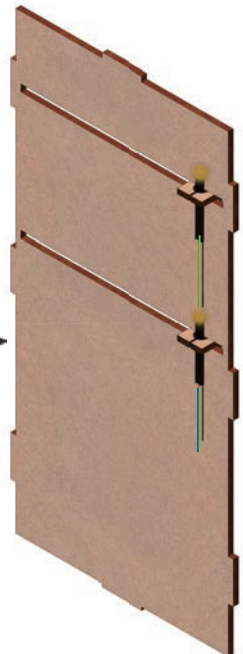
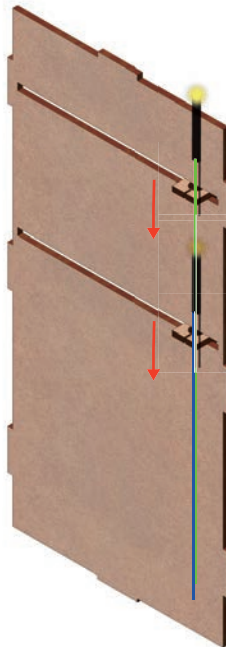

TIPS

Tidy up the light3 and light4 light cables before installation do not tangle them with other light cables. Test multiple times moving left and right to make sure the part can slide multiple times without falling off the backboard

安装前整理light3和light4的灯线不要与其他灯线缠在一起。多次测试左右移动确保该部件能够多次滑动不从背板上掉落

STEP 87



STEP86

STEP 88

TIPS

Push and pull the balcony on both sides of the upper level to see the interior of the different spaces. Slide the sliding bar that holds the light on the back to reveal different light changes as the light moves. Move the balcony and lights to your preferred location.

推拉上层两侧阳台，可以看到不同空间的室内。滑动背面固定灯的滑杆，可以发现随着灯的移动有不同的光影变化。移动阳台和灯光到你喜欢的位置。



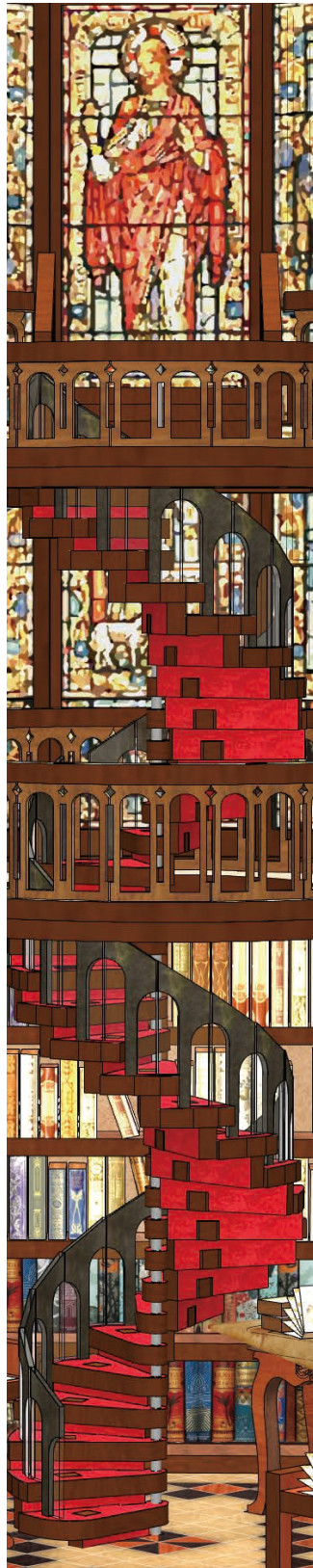

MiniCity

[THIS IS NOT ONLY A MINI CITY YOU BUILT]

漫城设计(深圳)有限公司
MiniCity Design (Shenzhen) Co.,Ltd.